

AQUANODE XL

USER GUIDE

Aquadyne

Version 1.0

First Edition

APRIL 2000

Copyright

© AQUADYNE Computer Corp., 1994-2000. All rights reserved worldwide. No part of this publication may be reproduced, transmitted, transcribed, stored in a retrieval system or translated into any language in any form by any means without the written permission of AQUADYNE Computer Corp.

Licenses and Trademarks

Octopus, AquaNode, AquaGuard, AquaWeb, H₂O/S are trademarks of Aquadyne Computer Corp.

Part Number: 75-052893

AQUADYNE Computer Corporation
7343 "P" Ronson Road
San Diego, California 92111
USA

Sales: (858) 569-2082
Tech. Support: (858) 569-2082 x250
Fax: (858) 495-3119
E-Mail: sales@aquadyne.com
support@aquadyne.com
Web: <http://www.aquadyne.com>

Printed in USA

1. INTRODUCTION

How the AquaNode Works	1-3
User Guide Features	1-4
Quick Reference Menu Map	1-4
Monitoring Capability	1-4
Flash Memory Architecture	1-5
Status Lights	1-5
Infrared Printer Port	1-6
Powering the AquaNode	1-7
Control Capability	1-7

2. INSTALLING THE COMPONENTS

Step 1. Mount the AquaNode Controller	2-4
Step 2. Install the Probes	2-5
Step 3. Install the Aux. I/O Module	2-11
Step 4. Install Optional X-10 Control Module	2-18
Step 5. Install and Address Optional Satellite Module(s)	2-18
Step 6. Install Communications Equipment	2-20
Step 7. Powering Up the AquaNode Controller	2-23
Step 8. Install the 12-Volt Backup Battery option	2-24

3. PROGRAMMING THE SOFTWARE

Overview of the AquaNode Menus	3-2
Using the Menu Map—An Example	3-4

Table of Contents

Initial Software Setup	3-4
Step 9. Set the System Clock	3-5
Step 10. Enter the Protective Password	3-6
Step 11. Set the Noise Filter Control	3-6
Step 12. Select the Conductivity Temp Compensation Settings ..	3-7
Step 13. Select Temperature Scale	3-7
Step 14. Select DO Operating Mode (YSI Only).	3-8
Step 15. Enter Setpoint and Range Values	3-8
Step 16. Entering Alarm Range Values	3-13
Step 17. Set up Digital Input	3-16
Step 18. Set up the Lighting System	3-16
Step 19. Set Up the WaveMaker System	3-17
Step 20. Assign System Control Addresses	3-18
Step 21. Set Up the Communication Software	3-18
Step 22. Enable the AquaNode System Control	3-25
Step 23. Test the System Configuration	3-26

4. OPERATION AND MAINTENANCE

Daily check list	4-2
Cleaning the Probes	4-3
Calibrating the Probes	4-8
Replacing a Probe	4-14
Conducting a System Test	4-14
Changing a Satellite Address	4-14
AquaNet Reporting and Graphing	4-14
Operating the Infrared Printer	4-15

5. TROUBLESHOOTING

Probe Troubleshooting	5-2
Peripheral Equipment Response Troubleshooting	5-5
Modem/pager Troubleshooting	5-6

APPENDICES

Appendix A: Menu Maps

Appendix B: Understanding Water Quality

Appendix C: Conversion Tables

Appendix D: Upgrading H₂O/S Flash System in the AquaNode

Appendix E: Product Warranty

Congratulations on your Aquadyne purchase.

This manual is available in an Adobe “pdf” format from our web page at **<http://www.aquadyne.com>**. For the latest information, electronic updates to this documentation and other technical information, we recommend that you check with us regularly.

Aquadyne Computer Corp.
7343 “P” Ronson Road
San Diego, California 92111
USA

Chapter

1

Introduction



Figure 1.1 The AquaNode XL Controller

HOW THE AQUANODE WORKS

Congratulations on your purchase of the most sophisticated, yet easy-to-use aquatic environment controller on the market today. Designed with a powerful INTEL™ microprocessor, your AquaNode™ XL controller includes the following features:

- Continuous monitoring of Dissolved Oxygen, conductivity, water temperature, pH and oxidation reduction potential (ORP).
- Environmentally sealed unit for operation in outdoor or wet environments.
- H₂O/S™ software with menu-driven programming environment.
- Optional Internal modem for remote operation via phone line.
- Aux. I/O system supporting 2 Analog/Digital Inputs and 2 Relay outputs.
- FLASH memory that makes upgrading your AquaNode with new H₂O/S software a simple task.
- Local audible alarm or optional remote dialup pager alarm capability.
- Parameter control capability for controlling peripheral equipment such as pumps, and lighting.
- Powerful datalogging capability that holds up to 30-days of probe data.
- Dual communications ports supporting both direct connect to a PC or remote modem communications and a network communications port allowing multiple AquaNodes to be connected via a RS-485 network.
- Wide operating power range (7V - 16V)

along with 12VDC battery backup capability.

- Built-in RS485 Optically isolated Network for networking multiple AquaNodes and support for the RCS (Relay Control System) for the addition of hardwired relays for control and alarming functions.
- Supports both YSI, and OxyGuard DO Probes. (Must state which probe is required at time of order.)
- An infrared Data Port that supports an optional hand-held HP printer for data reporting and graphical analysis.
- AquaWeb™ Remote Access—Our latest software product that allows you to communicate with your AquaNode, perform advanced graphical analysis of current and historical data—from any Windows 9X/NT/2000 PC.

Until now, performing even the simplest functions with a controller required technical or electronic expertise. The AquaNode controller makes maintaining the optimum aquatic environment easy.



The helpful Notes logo highlights items which will save you time and effort, and increase your understanding of the AquaNode operation.



The CAUTION logo highlights items which are critical to safety or which may cause the AquaNode to malfunction or become damaged.

Introduction

The AquaNode XL is constructed with only the highest quality components. The heart of the AquaNode is an INTEL microprocessor which manages all of the activities of the controller. All information gathered by the controller is processed digitally. The AquaNode Architecture includes Digital Signal Processing (DSP) hardware and software that guarantees accurate and repeatable readings over the life of the AquaNode. In addition, the microprocessor design provides unsurpassed flexibility, as reflected by the variety of software options that are available for the AquaNode.

AQUADYNE™ is committed to building products in the USA that meet world class standards of quality and workmanship. If you have any questions regarding the use of this product, AQUADYNE provides hotline service through the Technical Support Group. They can be reached between 8:30 AM and 5:00 PM Pacific Standard Time at (858) 569-2082 x 250 or via the Internet.

The primary source for technical and other useful information about the AquaNode, including the latest release of this User Guide in Adobe™ “PDF” format, can be found on our Web Page:

<http://www.aquadyne.com>.

Our Web Page always reflects the latest information about our products, so we suggest that you visit it frequently.

USER GUIDE FEATURES

The AquaNode User Guide is presented in five chapters: Introduction, Installation, Programming, Operation and Maintenance, and Troubleshooting.

In Chapter 1, we provide a basic overview of the AquaNode and its capabilities. We recommend that all users review this information before proceeding with Chapter 2, Installation and Software Programming.

This User Guide includes several quick reference features, including Notes, Cautions and a Quick Reference Menu Map.

QUICK REFERENCE MENU MAP

The laminated Menu Map included with your AquaNode summarizes the H₂O/S software menu structure. Post it in a convenient spot for quick reference. For more detailed menu maps, refer to Appendix A.

MONITORING CAPABILITY

The Standard AquaNode software provides for monitoring, control, and alarm capabilities. The five water quality parameters monitored and controlled are:

- Dissolved Oxygen (YSI or OxyGuard probe) depending on AquaNode Model ordered.
- Conductivity
- Temperature
- pH
- ORP

In addition to the five parameters the AquaNode also provides two aux. inputs which can be configured to provide 2 digital inputs or 1 digital input and 1 analog input for sampling a recorder output from another instrument.

Probes connected to the bottom of the AquaNode (Figure 1.1) gather information and relay it to the AquaNode for processing and display on the screen.

The AquaNode is programmed using a membrane keypad on the face of the unit. Directional arrows on the keypad are used to move horizontally across a given menu level. The “Enter” key is used to move down the menu map or to make a selection.

Once in the submenus, if there is no activity for ten minutes, the AquaNode LCD display window will return to the Current Status Display. Settings entered up to that time will be saved. When not in programming mode, current status information gathered by the probes is shown on the AquaNode LCD Display Window.

FLASH MEMORY ARCHITECTURE

A key feature of the AquaNode is that it is designed using FLASH memory and a special application *embedded* in the AquaNode called a *bootstrap loader*. When the loader is used in conjunction with other PC software offered by Aquadyne, routine updates to the AquaNode H₂O/S software can be easily accomplished. Refer to Appendix D for instructions on upgrading the H₂O/S software in the AquaNode. Additional Information about the current revision level of the H₂O/S software, the availability of AquaWeb for Windows 9X/NT/2000, and other technical details about the AquaNode can be found on the Aquadyne WEB page:

<http://www.aquadyne.com>.















Parameter Status Lights	
	No Light. (Parameter is within setpoints and no dosing required, OR control system is not activated.)
Conductivity	
	Solid Green. (System is dosing to lower conductivity value.)
	Flashing Green. Dwell State. (Will read conductivity again after dwell time is complete.)
	Solid Red. (System is Dosing to raise conductivity value.)
	Flashing Red. Dwell State. (Will read conductivity again after dwell time is complete.)
Temperature	
	Solid Green. Chiller On. (Current temperature is too high.)
	Flashing Green. Chiller Dwell State. (Dwell time to prevent compressor burn out.)
	Solid Red. Heater On. (Current temperature too low.)
pH	
	Solid Green. (CO ₂ is Dosing to lower pH.)
	Flashing Green. Dwell State. (Will read pH again after dwell time is complete.)
	Solid Red. (pH buffer is dosing to raise pH.)
	Flashing Red. Dwell State. (Will read pH again after dwell time is complete.)
ORP	
	Solid Red. (Ozone is dosing to raise ORP.)
DISSOLVED OXYGEN	
	Solid Green. (System is dosing to lower Dissolved Oxygen level.)
	Solid Red. (System is dosing to higher Dissolved Oxygen level.)

Figure 1.2 Parameter Status Lights

STATUS LIGHTS

Parameter Status Lights

The Parameter Status Lights located on the face of the Octopus indicate whether a system is operating within its preset limits or a control system has been activated. A status light lit red indicates that the system

Introduction

detected a low condition, a green light indicates a high condition.. A summary of Parameter Status Lights is given in Figure 1.2. In addition there are 2 Relay Status lights on the front of the AquaNode. They represent the state of the 2 Aux. Output relays inside the AquaNode. If the Relay #1





System Status Lights	
	Solid Green. Operating properly and available for data entry.
	Flashing Green. Busy processing data.
	Flashing Green/Orange. Sending commands through the power line to the Satellite Modules.
	Solid Orange. One or more setpoints are out of the normal habitat range of most fish.
	Flashing Red. Controller hardware failure. Unplug the Octopus controller and call Aquadyne customer service.

Figure 1.3 System Status Lights

light is green then that indicates that Relay #1 is energized. The same will hold true from Relay #2 as well. The contacts for these relays are available through the Aux. I/O connector on the bottom of the AquaNode.

System Status Light

The System Status Light located on the face of the AquaNode indicates the general condition of the AquaNode controller operating system. Figure 1.3 summarizes the System Status Lights and their meaning.

Dissolved Oxygen Probe Selection (YSI or OxyGuard)

There are a number of issues related to the use of Dissolved Oxygen probes in the AquaNode. The AquaNode is designed to support either YSI or OxyGuard DO probes. Probe selection must be done at the time you order the AquaNode. The controller can't be converted in the field to support the other probe.

OxyGuard probes also require that the probe be placed within 6 inches of the Temperature probe. This is required because the AquaNode uses a balanced input for the DO system and requires a ground reference to function. This ground reference is taken by the temperature probe.

The YSI probe can be located anywhere in the system as long as the water temperature is the same at the temperature probe



Your AquaNode is a precision laboratory instrument that could be damaged by unexpected power surges or fluctuations.

The use of a quality surge protection device is highly recommended, and is required to preserve your warranty.

and the DO probe. Temperature compensation for the YSI probe is performed by the AquaNode based on the temperature readings taken by the temperature probe.

Infrared Printer Port

The infrared printer port is located at the upper left hand corner of the AquaNode and is standard. This port provides access for the optional infrared data-log reporting feature. Using the Infrared Printer (optional) or AquaWeb, data collected by the AquaNode can be printed out in a variety of formats, including the current data, the high and low points of data collected within the last 24 hours, 48 hours, or 1 week. Temperature, pH, and ORP can be graphed. Conductivity, and DO will be added in a future release of H₂O/S software

Powering the AQUANODE

Primary power for the AquaNode is either a wall mount power transformer providing 7 to 16 VDC at 700 mA. or any battery providing voltage and current in the range stated. The AquaNode comes standard with a 12VDC 500 mA wall mount power supply. In addition a optional 12VDC battery backup input is available for powering the AquaNode should the primary power fail.

The AquaNode design incorporates FLASH Memory, RAM, and a battery backed-up real-time clock. Should power be lost, none of the parameter setpoints, or configuration data will be lost. However, during a power failure, data in the data-log will be erased if no backup power is provided to the unit.

Backup power is provided by one of two methods:

- An optional 12V Battery Backup Power System
- An optional UPS Backup Power System (Uninterrupted Power Supply). (The A/C wall-mount transformer is plugged into this system.)

The backup battery-pack will provide up to 24 hours of operation during a power failure if a 12V 7AH Gel cell is used. While operating from the battery pack, the AquaNode will continue to operate normally until the battery is exhausted and display the battery voltage on the status line in the display.

A optional UPS backup is also a good idea if you require more than 24 hours of backup power, or if you wish to backup other critical peripheral or communications equipment such as a pump, a bio-filter or a modem for example. Note however, that the duration of backup of the UPS is reduced by the addition of such equipment.

Introduction

RCS/Network Control Capability

The AquaNode XL offers several control options. Each AquaNode XL has 2 built in relays which can be directly programmed to perform management functions. In addition Aquadyne Relay Control System (RCS) can be integrated with the AquaNode to provide additional relay control function. Since the RCS communicates through the built-in

RS485 optically isolated network. Multiple RCS platforms can be integrated with multiple AquaNode's to provide extremely flexible control capability. Each relay on the RCS will switch up to 15 AMPS of power providing direct control for larger motors and pumps. Up to 16 devices including AquaNodes, RCS board, and AMS modules can be connected on a single 485 network. The network can stretch up to 1500 meters. This allows the RCS modules to be located away from the AquaNode XL systems which are managing them. Refer to the *RCS installation manual* for setup and configuration of a RCS system with the AquaNode XL controller.

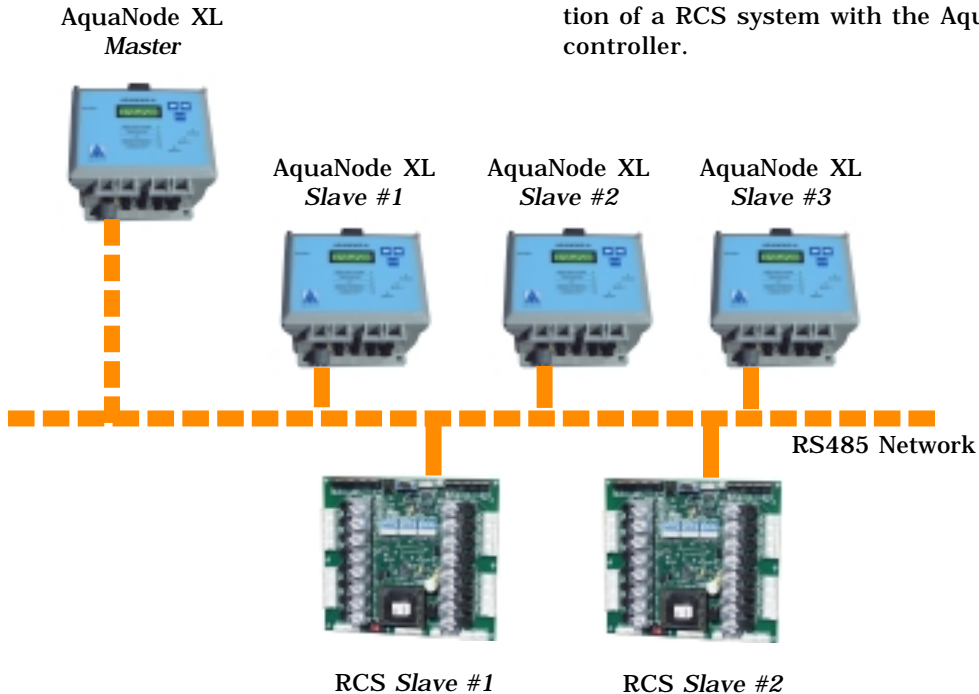

Figure 1.4 AquaNode Control System
Network & Components

X-10 Control Option

In addition to RCS support the AquaNode XL can also provide control via the optional X-10 control module and one or more satellite modules.



The proper and reliable functioning of the AquaNode and the X-10 control system is dependent on the proper installation of the AquaNode, the X-10 Control Module, and each Satellite Module. Other electrical devices, such as motors, ballasts, and dimmer switches produce electrical interference that may affect X-10 signaling. Refer to Chapter 5, Peripheral Device Troubleshooting, for further details. The X-10 system is not recommended for commercial applications with mission critical functions.

Control Using X-10 Management and Built-In Relays

The probes gather information and relay it to the AquaNode controller (Figure 1.4). Control of the systems is provided for using two approaches. The controller can directly control the system through the two built-in relay outputs or it can send commands through the optional X-10 control interface to the satellite modules. The satellite modules then receive signals transmitted from the AquaNode via the X-10 control interface and turn devices on or off as directed by the AquaNode. Each device that

Example Lighting Scheme

Timer 1 is for the fluorescent lamps. These lamps are the first lights to come on in the morning and the last to go off late at night.

Timer 2 is for the metal halide lamps. To approximate the sun rising, these lamps come on in the late morning and go off in the late afternoon.

Timer 3 is for an additional halide lamp. This lamp will come on for about one to two hours at noon to simulate the midday sun.

Timer 4 is for a red bulb during the night to allow observation of nocturnal creatures that come out when the lights are out, and or moonlight simulation.

If you have the 16-channel Lighting System and are not using all 16 channels, you can use the additional channels to control other devices.

Figure 1.5 Example Lighting Scheme

the AquaNode controls, such as a heater or chiller, can be programmed to use either the X-10 control system or the internal control relays. As many as 256 addresses and a variety of devices can be controlled by the AquaNode using X-10 control system.

The AquaNode incorporates several mechanisms to protect your aquatic environment from controller failure. For example, the controller is engineered to overcome problems associated with power fluctuations through the periodic re-sending of satellite module commands to make sure that a X-10 satellite is “latched” in the correct state.

In addition to controlling peripheral equipment to maintain water quality, the H₂O/S software supports other optional features that can be enabled on the control menus:

- A Lighting System
- A Interval Timer System
- An Alarm System

Each of these features is described in following sections.

Lighting System (16-Channel)

The lighting control feature allows the AquaNode to control your system lighting. The lighting system will support up to 16 independent lighting times per 24 hours. Each channel has one ON and OFF time per 24-hour period. The AquaNode comes standard with a 16 channel system.

With separate lighting timers, there is a high degree of flexibility in setting up your lighting system. For example, in your application you may wish to use a combination of metal halide, fluorescent, and incandescent lighting. And each lighting system may require a dedicated ON and OFF time. The AquaNode lighting system can manage these and other varied timing needs under software control.

Interval Timer System

The H₂O/S Dual Channel Interval Timer software feature allows the AquaNode to control two independent wave or surge generation systems. Each system supports two pumps which are driven by either the RCS module or, optional Satellite Modules. The cycle time for each pump is selected by the user, from 1-999 minutes (over 16 hours).

Alarm System

The H₂O/S alarm system software provides visual and audible notification in the event that a monitored parameter exceeds the user defined range. The optional pager alarm software upgrade used in conjunction with a modem provides remote alarm notification via a digital pager.

Chapter

2

Installing the Components

Installing the Components

This Chapter will provide you with simple step-by-step instructions to lead you through the installation process. But before continuing...

STOP—READ THIS FIRST



CAUTION

DO NOT ALLOW CONTROLLER TO GET WET!

Your AquaNode controller can be located in any dry location. The controller is not waterproof and cannot be submerged, permitted to get wet or exposed to high humidity. To avoid splashing the unit, install it properly as described in this chapter.

AVOID DANGEROUS OPERATING CONDITIONS

Do not operate the AquaNode controller under any of the following conditions:

- With wet hands.
- If you are standing in water.
- If the AquaNode Controller is wet.
- If there is salt creep on the box.

KEEP pH AND ORP PROBE TIPS WET AT ALL TIMES

To prevent loss of accuracy in the pH and ORP probes, be sure to keep the tips wet at all times. **NOTE:** Do not completely submerge probes. Refer to probe installation procedures (Step 2) in this chapter for more information.

INSTALL ALL ELECTRICAL CORDS CORRECTLY

Always take care when using electricity around water. To prevent water from running down the cord of an aquarium device, always use a drip loop as shown in Figure 2.0. To create a drip loop, make sure that the cord extends below the outlet so that any runoff will not enter the outlet or the device. Also, the AquaNode controller and ALL other aquatic environment devices should be plugged into a GFCI outlet.

If you are not familiar with installation of electrical equipment, it is strongly recommended that you hire a licensed electrician.

Installing the Components

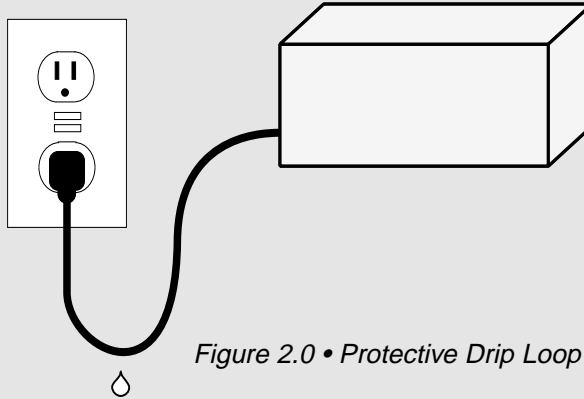

Figure 2.0 • Protective Drip Loop and GFCI Outlet



CAUTION

In addition to a surge suppressor, a Ground Fault Circuit Interrupter (GFCI) should be part of your installation. A GFCI is a sensitive device which immediately cuts off the electricity flow when an electric current leak is detected. **All devices that are part of the AquaNode system should be connected to a GFCI protected circuit.** If you do not have one installed already, you should purchase one. They are inexpensive and are available at any electronics or hardware store. **Don't wait, a GFCI can save your life!**

Installing the Components

INSTALLING THE COMPONENTS

There are two basic parts to installing the AquaNode controller:

- Installing the AquaNode hardware and additional components (Chapter 2, Steps 1 through 8).
- Programming the AquaNode (H₂O/S) software (Chapter 3, Steps 9 through 23).

Not all systems require the same installation steps. The steps required for each individual system will depend on:

- Whether the system is monitoring only or monitoring and control.
- Which optional components are included in the system.

Table 2.1 indicates which components installation procedures your system requires. For example, for Monitoring Only systems, only installation steps 1, 2, and 7 would be required.



The ORDER OF INSTALLATION is important to successful startup and operation of the system. The X-10 Control Interface, Satellite Modules, and Modem must be installed before the AquaNode controller is plugged in to ensure proper initialization of these components.

STEP 1—MOUNT THE AQUANODE CONTROLLER

The AquaNode controller will need to be installed within 5 to 10 feet of the probes. If you wish to place the controller beyond the standard 10-foot length of the probe cables, additional cable is available in a variety of lengths through special order.

The controller comes with four mounting hangers for easy installation. Use the screws provided to attach the controller to the wall.

<i>Steps to Install Physical Components</i>	<i>Monitoring System</i>	<i>Monitoring & Control System</i>
1. Mount the AquaNode Controller	✓	✓
2. Install the Probes	✓	✓
3. Wiring Internal Relays or RCS and Inputs	N/A	✓
4. Install X-10 Control Module	N/A	✓
5. Addressing of Relays or Satellite Module(s)	N/A	✓
6. Installaion of Optional Modem	Optional	Optional
7. Power Up the AquaNode XL Controller	✓	✓
8. Install 12-Volt Backup Battery Pack	Optional	Optional

Table 2.1 • Installation of Components

Installing the Components

STEP 2—INSTALL THE PROBES

Up to five probes can be installed as part of the AquaNode system. Three of the probes (temperature, pH, ORP) have the same basic installation requirements. The conductivity probe, requires special installation procedures to ensure proper operation and accuracy. Since the AquaNode can be purchased to support either a YSI or OxyGuard DO probe, the installation requirements specific to each probe (YSI or OxyGuard) are broken out in each step of the installation.

In all cases, it is desirable to locate the probes away from sources of electrical interference such as UV sterilizers, florescent lighting, ballasts, pumps, etc.



Note

The AquaNode is a precision instrument that has been designed to interface with high-quality laboratory grade probes manufactured in the USA to Aquadyne specifications. The use of other probes (especially inexpensive imported probes) not approved by Aquadyne is not recommended and will not be supported.

A genuine Aquadyne probe can be identified easily by the presence of date code stamped on the top of the probe shaft.

PROBE UNPACKING



CAUTION

- pH, ORP, and DO probe tips must be kept wet at all times. The probes should be installed immediately after their tips are exposed to air. If probes are allowed to dry, they may be damaged and may produce inaccurate readings.

- To prevent damage to the ORP probe sensor, **FIRST REMOVE THE TAPE OVER THE VENT SEAL** on the protective cap. Then remove the protective cap.
- Remove the protective caps from the remaining probes and install per Step 2 instructions.

OTHER CONSIDERATIONS

- A new probe requires a minimum of 48 hours to stabilize after installation. **DO NOT ENABLE AQUANODE CONTROL OF PARAMETERS FOR 48 HOURS.**
- Be sure probes are plugged into the correct AquaNode probe ports. If they are plugged into the wrong ports, the system will not monitor properly.
- Place temperature, pH, & ORP probes within 6 inches of each other.
- The conductivity probe should be located away from the other probes, 36" min.
- With the exception of the Dissolved Oxygen Probe do **NOT** totally immerse any of the other probes in water.

Installing the Components

Installing the Temperature, pH, DO, and ORP Probes

The four steps in probe installation are:

1. Select a location for the probes that will allow the pH and ORP probes to be placed within 6-inches of the temperature probe. (Alternatives are described in this section). By placing the probes close to each another, the AquaNode is assured that the probes are not subject to different electrical environments that could affect their accuracy. The conductivity probe is a special case and should **NOT** be placed with the other probes. The diagram below shows the conductivity probe placed in-line back to the pump. The installation requirements for the YSI and OxyGuard DO probes are different.

YSI Probe Installation:

The YSI DO probe can be placed anywhere in the system as long as the water temperature surrounding the temperature and DO probes are the

same. This is due to temperature compensation requirements of the YSI DO probe. Also, insure that there is adequate water movement of not less than 3 cm/sec across the membrane of the electrode.

OxyGuard Probe Installation:

The OxyGuard DO probe **MUST** be placed within 6 inches of the temperature probe. The probe uses the temperature probe as a ground reference like the pH and ORP probes.

The probe must **NOT** be located above diffusers or near aspirators etc. because the bubbles will cause erroneous readings. The probe must also be mounted with the membrane surface of the electrode pointing up (See Figure 2.3) to avoid bubbles collecting on the membrane surface. Use either a tie-wrap or tape to secure electrode. Also,

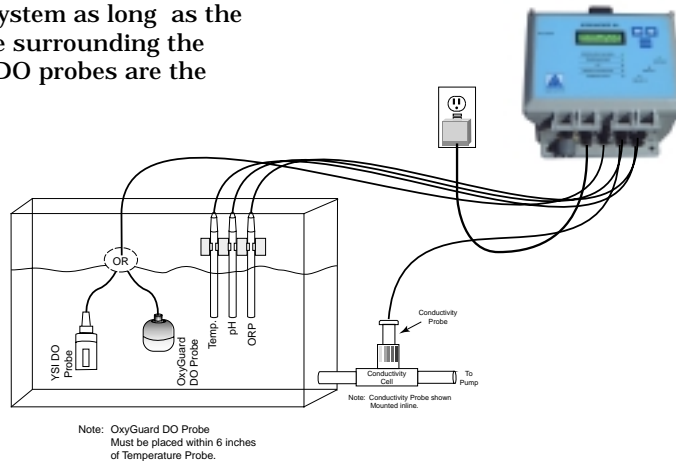

Figure 2.2 • In-Filter Location Using Probe Mounts

Installing the Components

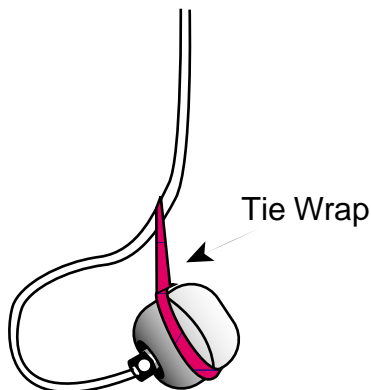

Figure 2.3 • OxyGuard DO Probe Mounted with Membrane Pointed Up.

insure that there is adequate water movement of not less than 3 cm/sec.

2. Remove the vent seal on the ORP probe protective cap, then remove all protective caps.
3. Plug the probe connector cables into the designated port at the bottom of the AquaNode controller.
4. Place the probes in the location selected in Step 1. None of the probes can be submersed except for the DO probe. Mount the probes so that the top of the probe is above the water line. The probes should be positioned so that **ONLY ABOUT HALF** of the probe shaft is immersed in water. Both the YSI and OxyGuard DO probes are designed to be **fully submersed** and needs to be placed in a location with good flow to insure

accurate readings.

Alternative Probe Locations

Select a probe installation that will allow the pH, ORP, and (OxyGuard if used) probes to be located within 6 inches of the temperature probe.

Three possible probe installations are:

- In-Filter Location Using Probe Mounts (Figure 2.2).
- In-Filter Location Using a Float (Figure 2.4).
- In-Line Location Using Tee-Fittings (Figure 2.6).

In-Filter Location Using Probe Mounts—

The most common place for probe location is in the filter. Installing probes in a filter or sump requires that the probes be secured using probe mounts that attach to the back of the filter so the probes are only half-immersed in the water, (See Figure 2.2.) When placing your probes, be sure that there is adequate water flow over the probe tips at all times. The pH and ORP probes must be placed within 6 inches of the Temperature Probe.

In-Filter Location Using a Float—The float installation shown in Figure 2.4 keeps probes from being submerged (or drying out), and is economical to construct.

To construct a probe float, punch a hole (slightly smaller than the probe diameter) through a small piece of styrofoam. Be sure the probes are no further than 6 inches apart. Insert the probes into the float, as shown in Figure 2.4.

Installing the Components

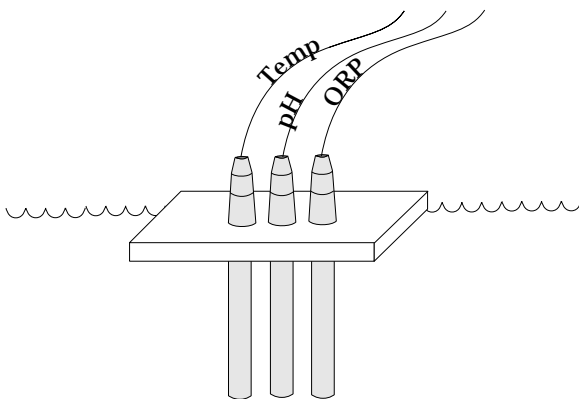

Figure 2.4 • In-Filter Location Using Float

In-Line Location Using a Tee-Fitting— Although in-line probe placement is a little more difficult and requires some extra plumbing, it has been found to be a very accurate and safe way to place your probes. In-line placement will give accurate readings because water is moving across the probe tips at all times, and because algae growth on the probe tips is minimized.

The probe is placed into a tee-fitting, as shown in Figure 2.6. You will need to provide the tee-fitting for this installation. The diameter of the in-line portion of the tee should be 1/2



Note If the conductivity probe is not installed in a conductivity cell or if the probe is exposed to electrical interference from pumps, motors, or electrical ballasts, unreliable readings will result.

inch (3/4" for conductivity probe) regardless of whether you are using laboratory or standard grade probes as they are supplied from Aquadyne. Aquadyne offers two compression fittings for installation of the probes.

Be sure to install water shut-off valves, as shown in Figure 2.6, to permit probe replacement. All fittings must be secured so there is no water leakage.

It is important that the in-line probe extend no more than about 50% into the flow stream. If the probe protrudes too far into the flow stream it will interrupt flow and interfere with the accuracy of the probe readings.

Conductivity Probe Selection

The AquaNode supports 2 different conductivity ranges, 0-2000uS and 0-200mS. The range is determined automatically by which conductivity probe is used with the AquaNode. The low range probe configures the AquaNode to monitor and control over a range of 0 to 2000 uS while the high range probe configures the system to operate from 0 to 200 mS (0 to 200,000 uS).

PN 68-010565 Low Range Lab Cond. Probe
PN 68-012872 High Range Lab Cond. Probe

The correct probe must be connected up to the AquaNode before powering up the instrument. The AquaNode will determine which probe is connected and configure the instrument for that operating range.

Installing the Conductivity Probe

Installation of the conductivity probe is similar to the installation of the pH, ORP and temperature probes discussed previously.

Installing the Components

1. Select the proper probe location away from the other probes.
2. Remove the probe protective cap.
3. Plug the probe connector cable into the conductivity port at the bottom of the AquaNode controller.
4. Place the probe in the location selected in Step 1.

Alternative Probe Locations

The conductivity probe must be located away from the other three probes, and the conductivity probe must be installed in a controlled volume environment called a “conductivity cell.” (See Figure 2.5)

The conductivity cell provides the conductivity probe with a controlled volume environment. The conductivity cell is required to achieve accurate conductivity readings. It reduces the chances that the conductivity

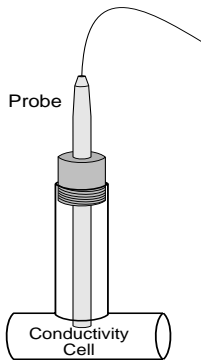

Figure 2.5 • In-Line Conductivity Cell

probe will be affected by alternate ground (conductive) paths.

The conductivity probe can be installed in either of two ways:

- In-line, using a tee-fitting.
- Off-line, using a “Drip Cup.”

In-Line Location

The in-line installation shown in Figure 2.6 is the preferred installation method because the tee-fitting is a natural conductivity cell and it provides the most accurate measurement environment.

The general procedure is the same as that described above for temperature, pH and ORP probes. However, the conductivity cell, is utilized. Be sure that the installation provides that about 10% of the probe protrudes into the cell. Aquadyne provides a “score-mark” on all of its conductivity probes that guides installation and assures proper insertion depth.

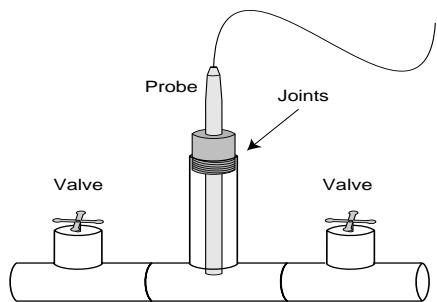

Figure 2.6 • In-Line Location Using Tee Fitting

Installing the Components

Off-Line Location

The “Drip Cup” installation is a second option for the conductivity probe installation. As illustrated in Figure 2.7, a portion of water from the pump discharge line is diverted to a small cup-type arrangement.

The water flows in and out of the cup at a rate of about 1 cup per minute.

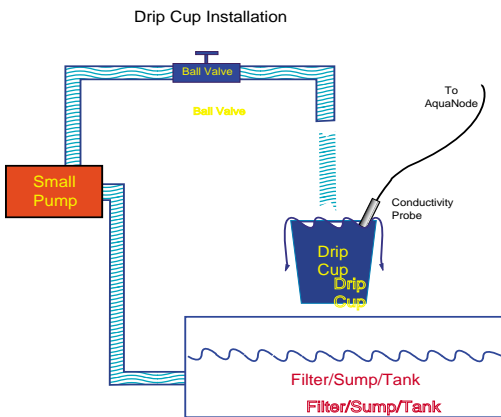

Figure 2.7 • “Drip Cup” Installation

In a drip cup installation, there is no compression fitting to control insertion depth—you must carefully position the probe so that the end of the probe is approximately 1 inch from the bottom of the cup.

Stabilization Period for Probes

After the probes are installed, there is a period of time required for each probe to stabilize in its new environment. The conductivity probe will be the first to stabi-



Note

The AquaNode has been calibrated at the factory to pre-set standards. Since each probe has its own unique measuring characteristics, it is always recommended that you perform a manual calibration allowing sufficient time for the probes to stabilize in the calibration solution.

lize in only 5 minutes, followed by the temperature probe which requires about 10 to 15 minutes before accurate readings are possible. The pH and ORP probes will take considerably longer to stabilize. Their readings are much more sensitive. The pH probe will stabilize in about 24 hours while the ORP probe may require 48 hours. The start up requirements for the YSI and OxyGuard DO probes are different. Refer to the correct section for the start up procedure for the probe that you are using.

Preparing the YSI DO probe for First Use.

The YSI DO probe is shipped wet with a shipping membrane installed. This protective membrane cap on the probe tip must be removed and replaced with a new membrane cap filled with MEA probe solution before using the probe. Follow the instructions in Section 4 (Operations and Maintenance) of this manual regarding membrane cap replacement and probe calibration. Make sure to provide a minimum 20 minute warm up period before attempting to calibrate the DO probe.

Installing the Components

It is critical in the calibration of the YSI DO probe to allow the DO probe and Temperature probe to achieve the same temperature level. Allow a minimum of 10 minutes for both probes to reach thermal equilibrium before proceeding with DO calibration. In addition allow a minimum of 20 minutes of system operation with the DO probe installed to allow the DO probe to stabilize before either calibration or operation.

Choosing the Right Membrane Cap for the YSI Probe

Two different membrane caps are available for the YSI MEA probe. The YSI Model 9501 Membrane Cap Kit contains six 0.5 mil (0.0005") membrane caps and a bottle of MEA probe solution (KCI). The 9501 membrane caps offer the fastest response to changes in DO and are recommended for most applications.

For conditions with low flow or stagnant water, a 1 mil (0.001") membrane is available (YSI Model 9502 Membrane Cap Kit). This membrane requires less stirring than the 9501, but has a slower response. Use this membrane when minimal stirring (<2"/sec) is available.

Preparing the OxyGuard DO probe for First Use.

The OxyGuard DO probe is shipped with a air tight cover over the membrane. This protects the membrane in shipment. Follow the instructions in Section 4 (Operations and Maintenance) of this manual regarding probe calibration. Make sure to provide a minimum 20 minute warm up period after removing the protective cover before attempting to calibrate the DO probe.



Note

Make sure to install the calibration adapter before attempting to calibrate with the OxyGuard probe and remove it after calibration is complete (See Section 4).

STEP 3—WIRING INTERNAL RELAYS AND INPUTS

The AquaNode XL comes with terminal blocks built-in providing an easy means to connect up to two external sensors, and 2 contactors (relays) for controlling a variety of systems (ie pumps, heaters, chillers, etc.). The location of the terminal blocks is shown in 2.8 below. The relays can operate in both a normal or powered mode. In the powered mode, power from the AquaNode's Power supply (12Volts at up to 125 mA) is applied directly to the common of each relay allowing 12 volt contactors to be controlled directly without the need for a separate power supply. In normal mode the common, normally closed, and normally open for each relay is made available on the terminal block. Powered and Normal operation for each relay is selected by a jumper located under each terminal block. Two inputs are available with a single common return for each input.

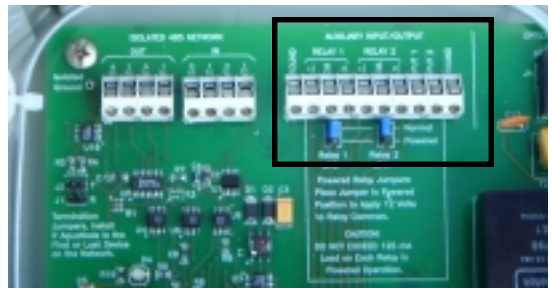

Figure 2.8 • Aux I/O

Installing the Components

Using the Inputs

The two Aux. Inputs in the AquaNode can be configured in a number of ways. Both inputs can be used as conventional digital inputs allowing a variety of sensors to be connected to the unit. In addition Input #2 can also be used as an optional external analog input. This allows an external instrument with a recorder output port to drive the AquaNode. The AquaNode can be configured to operate with either a 0-1 or 0-5 Volt range. The signal is then converted into a 10 bit digital value and stored in the AquaNode's data-log making it available to AquaWeb. Up to 30 days of hourly observations from input #2 are stored in the AquaNode along with the existing parameters (ie DO, and pH). An internal jumper in the AquaNode determines if the input range is 0 to 1 Volt or 0 to 5 volts.

Input Options		
Input #	Digital	Analog
1	X	
2	X	X

Table 2.2 • AquaNode Aux. I/O Inputs

The inputs operating as digital inputs allow various system conditions, such as high or low water levels, high or low pressures, or flow failures to be detected and alarmed. This section provides instructions for installing a float switch (water level detection), and a contactor to control a large pump or motor.

Aquadyne offers a number of sensors which can be connected to the AquaNode's digital inputs for detection of water level, pres-

sure, and flow. An example of a float switch connection is shown in Figure 2.9.

Installing a Float Switch

A float switch consists of a stationary stem and a float that moves up and down with the water level. A small magnet mounted inside the float causes a reed switch to open and close based on the position of the float.

Install the Float Switch in Tank or Filter

The float switch should be installed in the tank or filter at the desired level, according to the manufacturer's instructions. (Many float switches will require drilling into the tank at the desired float location.) Be sure the float is installed in such that the float is allowed to move freely.

Once the float switch has been installed in the tank or filter the switch can then be connected to the Input #1 or #2 in the AquaNode XL. Figure 2.9 shows a float switch connected to Digital Input #1. One wire is connected to the terminal labeled 'Ground' and the other is connected to Input #1 on the terminal block located in the AquaNode XL. A second sensor would be also be connected to the 'Ground' terminal and the other wire to Input #2.

Using AquaNode's Built in Control Relays

The 6 additional terminals in the Aux I/O module are for accessing the two built-in control relays in the AquaNode. These relays are available to any system in the controller by selecting a 'R' address in the Set Control Addr menu. Relay 1 is accessed by a R-1 setting and Relay 2 by a R-2 setting in the Set Control Addr menu. Both relays

Installing the Components

have 3 separate terminals available for control. Common, Normally Open, and Normally Closed connections are provided for each relay. Typical control applications will use the Common and Normally Open terminals. This will allow an external device such as a heater, chiller, or pump to be turned on when the relay in the AquaNode is active. A visual indication of the state of the relays is available on the front of the AquaNode. When the relay light is green the relay is energized.

Using Relays in Normal Mode

With the jumper for a relay in the Normal position (Jumper nearest the terminal block). The Relay's contacts are directly brought out to the terminals. The three terminal positions are defined as the Normally Closed contact (N.C.), the Common contact, and the Normally Open (N.O.) contact. Each relay has both N.O. and N.C. contacts available.



The AquaNode built in relays in Normal Mode are designed to switch low voltage and current devices. The MAXIMUM voltage used in the control circuit should not exceed 24 VAC/VDC. Current should not exceed 1/2 amp. Max. Caution should be exercised to insure these limitations are met.

Using Relays in Powered Mode

With the jumper for a relay in the Powered position (Jumper away from the terminal block). 12 Volt power is provided on the common terminal. To connect a contactor up to AquaNode, you would wire one side of the contactor to the Normally Open "N.O.", or the Normally Closed "N.C." (Depending on whether you wanted the contactor energized or not when the internal relay is deenergized) terminal and the other wire of the contactor to the Ground terminal on the left side of the terminal block. Make sure you do not exceed 125mA load on each relay in energized mode.

Using a Contactor with the AquaNode's built-in relays.

The internal relays in the AquaNode are designed to switch a small amount of voltage less than 24VAC or DC and a Current draw of less than 1/2 Amp. In order to utilize the built-in control relays typically a separate switching relay needs to be installed between the device being controlled and the AquaNode. This device called a contactor provides the needed contact power rating to reliably switch large loads from motors and other high current devices. The contactor used will need to have a coil voltage of less than 24Volts. The

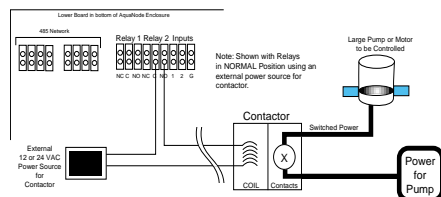

Figure 2.10 • Contactor Installation (Normal Mode)

Installing the Components

contactor needs to be sized to meet the switching loads required. Figure 2.10 shows the typically method of connecting a contactor to the AquaNode Aux. I/O module.

Using the AquaNode XL with the Relay Control System

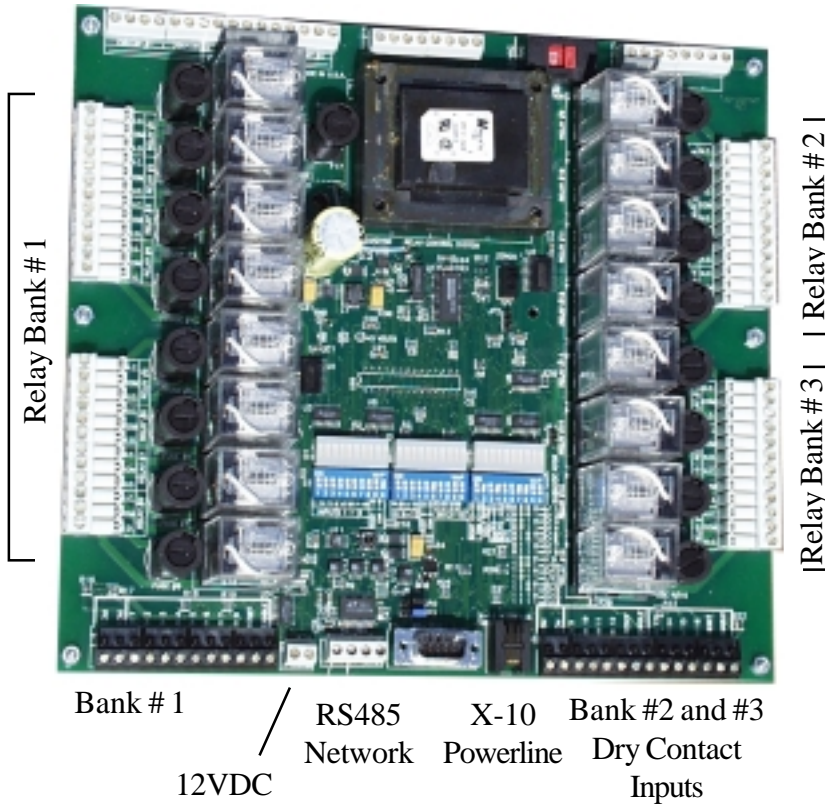

Figure 2.11 The Aquadyne Relay Control System (RCS)

Installing the Components

RCS General Description

The Relay Control System (RCS) shown in figure 2.11 is designed to provide users with the ability to control up to sixteen high current plug-in type industrial relays. Each relay will switch up to 15 Amps (7 Amps Inductive) at 110VAC/220VAC. The RCS is available in either an 8 or 16 relay configuration. The RCS can be managed using one of 3 different control interfaces. The RCS will accept commands from one of 3 different control interfaces: X-10, RS-232, and RS-485. Through the use of the RS-485 interface, the RCS can reside on a AquaNode network provides unlimited control expansion for the AquaNode line of controllers. Through the use of Aquadyne's subnetwork addressing scheme multiple RCS units can be placed on a AquaNode network, providing extremely flexible control capabilities. For example a single RCS can receive commands from multiple AquaNode's, thus allowing the RCS unit to be shared among multiple AquaNode controllers. Figure 1.2 shows a typical AquaNode network with RCS and AMS peripheral units attached.

The RCS relays are rated to handle up to a 15 AMP resistive load, with a maximum inductive load of not to exceed 7 amps.

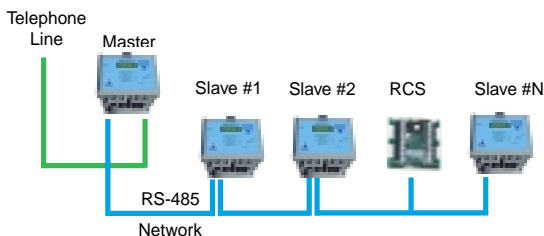

Figure 2.12 Typical AquaNode Network

Each relay on the board is socketed for easy maintenance.

Configuration of the RCS is accomplished via 3 banks of switches providing easy configuration in the field. Each switch has a indicator light making switch status easy to determine at a glance. The RCS is switch selectable for either 110VAC or 220VAC operation. The onboard power supply has a separate field replaceable fuse for ease of maintenance. For complete installation and configuration information on the RCS refer to the RCS installation and Configuration Manual that comes with the RCS module.

AquaNode XL Isolated RS-485 Interface

The AquaNode's RS485 Optically Isolated Interface is located next to the Aux. I/O terminals and is shown in the figure 2.13 below. Up to 16 AquaNode's and RCS modules can be connected via the network. This provides significant flexibility in regard to alarming, monitoring and control.

RCS Isolated RS-485 Interface

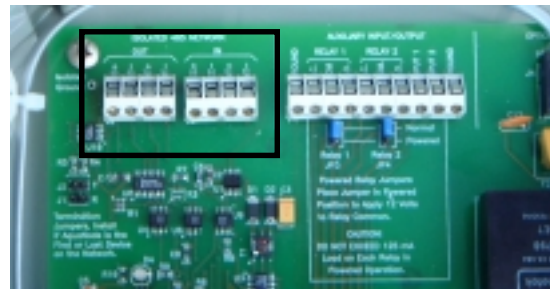

Figure 2.13 AquaNode XL 485 Interface

Installing the Components

Using a standard RS-485 multi-drop interface. This allows the RCS to be connected to the AquaNode RS-485 network. Multiple RCSs are supported in this manner. The sub-node address for the RCS is set by the 4 address switches. Make sure the X-10 and RS-232 Switches are in the OFF position and the RS-485 switch is set to ON.

The RCS Board at location J12 provides transmit and receive connections for the RS-485 interface. Refer to the section on subnode networking for interfacing the RCS board to the AquaNode Sub Network. Connections to the RS-485 network are made at terminal block J12 as shown below. Connections to the network are defined as follows:

Terminal Connection Description

1 Receive (+) Receive Positive Data from

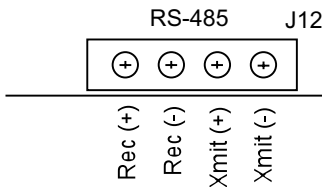

Figure 2.14 RCS Network Terminal Block

Network

2 Receive (-) Receive Negative Data from Network

3 Xmit (+) Transmit Positive Data to Network

4 Xmit (-) Transmit Negative Data to Network

Network Wiring

The LAN network consists of 2 pair of category 5 twisted pair cable. You can use Category 3, 4, or 5 cable. We recommend that you use Category 5 cable which has the following color scheme. Color schemes will vary from cable manufacturer. Here is an example with Ethernet Category 5 cable. The color scheme used in the wire is as follows:

Pair #1: Solid Blue Wire and White Wire with Blue Stripe

Pair #2: Solid Orange Wire and White Wire with Orange Stripe

When wiring up the AquaNode XL's connections should be made as follows:

1. All Subnodes or RCS's should be connected as follows:

Wire Terminal Connection

Solid Blue Wire	1	Rec(+)
White w/Blue Stripe	2	Rec (-)
Solid Orange Wire	3	Xmit (+)
White w/Orange Stripe	4	Xmit (-)



Note

It is critical that the Xmit connections (+,-) be connected to a twisted pair in the cable along with the Receive connections (+,-). Twisted pairs in the cable can be determined by stripping back the outer insulation to determine how the wires are paired. Failure to match pairs will result in data transmission errors on the network.

Installing the Components

2. The Master Node should be wired as follows:

Wire	Terminal Connection
SolidOrange Wire	1
White w/Orange Stripe	2
Solid Blue Wire	3
White w/Blue Stripe	4

Address of 2 the settings would be “S1-1” if Relay #1 was used on the RCS module.



Note

In a network configuration it is important that each device on the network be given a unique address. No two devices are allowed to share the same subnode address.



Note

Note: In Network Test Flash Mode only the AquaNode Slave units LED's flash. The master AquaNode LED's do not flash.

Sub-Network Programming

The programming of the AquaNodes to support subnetworking consists of setting the Sub-Node address in each controller in the network. The node address is located in the Datalogger Sub Menu under the setup menu. To set up the network, first set the master node to an address of zero. Then assign a unique number from 1 to 31 for each of the sub-nodes on the network. You must make sure that each node is assigned a unique sub node address. If two nodes share a common sub-node address, neither node will operate correctly on the network. Under the Set Control ID, RCS boards are addressed with a subaddress of 'S' followed by the RCS address that the board is set to followed by the Relay Address 1 - 16. For example if you were controlling a Heater from a AquaNode on a RCS module with a Sub-

A network test feature is designed into the system to allow you to test to insure that the network is wired correctly. The master node has an additional menu label Test Flash On and Test Flash Off. Setting the menu on the master node to Test Flash On will cause all the slaves Aquanodes status lamps to flash on and off. This will allow you to check to insure that the slave nodes are wired up correctly. After proper network connections are established. Execute the Test Flash Off menu item to stop the subnodes from flashing.

Installing the Components

Step 4—Install the Optional X-10 Control Module

To install the X-10 control module, simply plug it into a GFCI electrical outlet. Then use the 4-wire interconnect cable provided with your unit to connect the X-10 control module (X-10 port at the bottom) to the AquaNode controller. For proper initialization of these components, remember to connect your X-10 control module and satellite modules before powering up your AquaNode unit.



Note

The X-10 control interface and all satellite modules must be installed on circuits of the **SAME PHASE**. If the X-10 control interface and the satellite are not on the same phase, they will not be able to communicate with each other, except by means of a satellite bridge.

Do not plug satellites or the X-10 control module into power strips equipped with surge suppression. Surge suppression will filter out the AquaNode control command signals.

STEP 5—INSTALL AND ADDRESS OPTIONAL SATELLITE MODULE(S)

The satellite modules can be located wherever electrical power is available. It is essential, however, that the AquaNode

controller, the X-10 control module, and all satellite modules be located on circuits on the same phase in the electrical sub-panel and have the distance of the A/C wiring between the X-10 control module and any satellite not exceed 50 feet. Otherwise, these devices may not communicate properly.

One satellite module will be needed for each peripheral device you want to control, as shown in Figure 2.15.

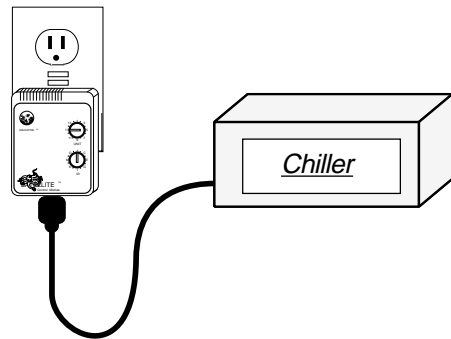

Figure 2.15 • Satellite Module Installation

To install the satellite module, simply plug the module into a GFCI-protected electrical outlet. Then plug the device to be controlled (i.e., pump, heater, chiller) into the bottom of the satellite module.

Be sure you do not exceed the power specifications of the satellite module. The satellite modules operate on power lines up to 110 volts and can be used with devices up to 5 amps. Satellites which operate with higher voltage and amperage or with different international plug configurations, are

Installing the Components

available from your dealer.

The AquaNode controller identifies each satellite by its own code, which is called an address. A control address must be set for each satellite module.

The address is selected using the two dials on the face of the satellite module, as shown in Figure 2.16. The alpha dial allows selections A-P and the numeric dial allows selection 1-16. The satellite address shown in Figure 2.16 is A-3.

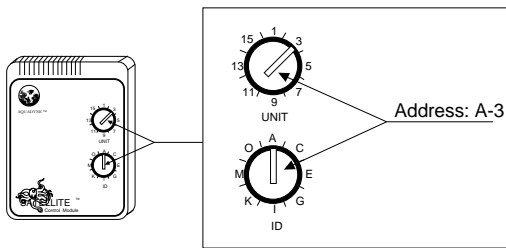

Figure 2.16 • Addressing a Satellite Module



A sticker on each satellite module indicates the maximum load-rating of the device. **DO NOT OVERLOAD.** Equipment such as compressors and pump motors can exceed the load rating of a satellite module. Verify with the manufacturer of your peripheral device that the surge current at startup does not exceed the load rating of the satellite module. Damage to the satellite unit could result!

In addition, be sure you are using the correct plug configuration.

Default Satellite Addresses

A-1	Heater
A-2	Chiller
A-3	Ozonizer
A-4	pH Doser
A-5	CO2 Doser
A-6	Not Assigned
A-7	Alarm Module
A-8	Low Conductivity Control
A-9	High Conductivity Control
B-1	WaveMaker Pump 1A
B-2	WaveMaker Pump 1B
B-3	WaveMaker Pump 2A
B-4	WaveMaker Pump 2B
C-1	Timer 1
C-2	Timer 2
C-3	Timer 3
C-4	Timer 4
F-1	Timer 5
F-2	Timer 6
•	
•	
•	
F-12	Timer 16
F-15	DO Range #1 Low
F-16	DO Range #1 High
G-1	High Conductivity Alarm
G-2	Low Conductivity Alarm
G-3	DO Range #2 Low
G-4	DO Range #2 High

Available for use:

- R-1 = Internal Relay #1
- R-2 = Internal Relay #2

Table 2.2 • Default Satellite Addresses

Installing the Components

Before assigning any addresses, you should make a list of all devices to be controlled and their proposed satellite addresses. You may wish to choose addresses to coincide with default addresses provided by Aquadyne shown in Table 2.2. Satellite addresses will also have to be entered in the AquaNode software. (Refer to installation procedure Step 21.)

STEP 6—INSTALL THE COMMUNICATIONS EQUIPMENT

There are two communication features available for the AquaNode system:

- Alarm Paging
- AquaWeb for Windows 9X/NT

The **alarm paging feature** allows your pager to receive an alarm page when a water quality parameter goes outside the acceptable range or when a digital input switch signals an alarm condition. The pager

message indicates which AquaNode unit (via the last 3 digits of the unit serial number) is affected (in the event of multiple units), which parameter is involved, and whether the alarm represents a high or low condition. (Refer to Chapter 3, Step 23 for a discussion of pager message information.)

As shown in Table 2.3, in order to have the alarm paging feature, you must install a modem to your system.

AquaWeb provides remote access to the AquaNode internal data-log and permits network communication between a PC and the AquaNode. Depending on the software version of AquaWeb, some of the features include remote communications, trend analysis and networking with extensive graphing, statistical and data export capabilities.

As indicated in Table 2.3, there are two ways to access AquaWeb:

- Via modem
- Via direct cable connection

Communication Feature	Connection Options Available	
	Modem	Direct Cable Connection
Alarm Paging Only	✓	N/A
AquaWeb Only	✓	✓
Both Alarm Paging & AquaWeb	✓	N/A

Table 2.3 • Communication Options

Installing the Components

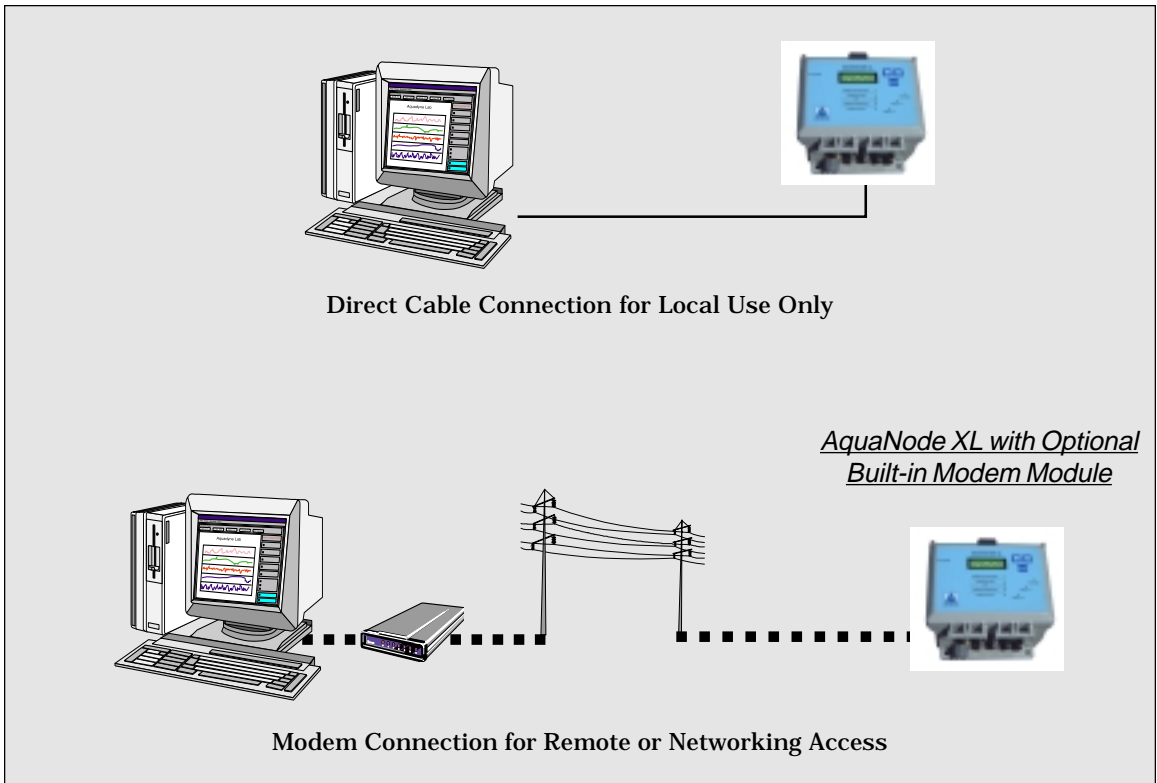

Figure 2.17 • AquaNet using Direct Cable or Modem Connection

For a single PC to a single AquaNode, a direct cable connection can be used (refer to Figure 2.17). Note that if a direct cable connection is used, alarm paging will not be available. (Both the direct cable connection and the modem connection require a serial port connection. And PCs typically have only one serial port available.)

For remote access to the AquaNode data-log or for networking two or more AquaNode units, a modem connection is required.

Installing the Internal Modem

The internal modem option for the AquaNode XL consists of a Modem module which plugs into the modem module socket on the lower circuit board. It is important to insure that the module is correctly oriented to avoid damage to the module or AquaNode. In addition to the module a short 5 conductor cable is also included which needs to be plugged into the lower board (j5) on one end and connector P2 on the upper board. Note: The connector at P2 already has a cable plugged into it and will need to be unplugged

Installing the Components

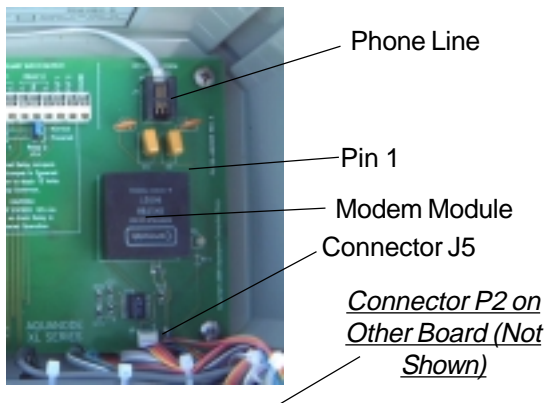

Figure 2.18 • Installing the Modem

so that the modem cable can be plugged in. The connectors are keyed so they will only plug in one way.

2. **Power Up the AquaNode XL**—With the modem module and cable installed you can now power up the AquaNode. To the right of the modem module is a status indicator. When the AquaNode XL first powers up the indicator will be orange. Once the modem is initialized by the AquaNode the indicator will turn to green. The indicator will also



There could be problems in modem operation and pager functionality if the telephone line is shared. For proper operation, the modem will require a dedicated telephone line.

indicator that a connection to the unit has been established by turning from green to orange.

3. **Connect the Modem and Phone**—The modem is supplied with a 6-foot telephone cable to connect the modem to the telephone company (telco) phone line. Plug the phone cable into the phone line connector located on the board above the modem module.. Connect the other end of the phone line to the closest telco live telephone jack.

If your installation does not use this type of phone connection, adapters are available through your local hardware store. With the cable connected to the phone line, you are now ready to program the H₂O/S software for modem use. (Refer to Chapter 3, Step 23.)

Installing the Direct Cable Connection

Your AquaNode Controller with its H₂O/S system software can be configured to connect directly to a PC by using Aquadyne's direct cable connection. Once connected, the AquaNode can communicate with AquaWeb for Windows 9x/NT/2000, Aquadyne's remote access application.

To hook up directly to the PC, one end of the direct cable connects to the serial port on the AquaNode unit and the other end connects to your PC com port. Aquadyne provides a optional 25-foot cable and, for a longer run, a 25-foot extension cable.

Along with the cabling issue the AquaNode allows you to control a number of different serial data options such as baud rate, parity, and software flow control.

Installing the Components

STEP 7—POWER UP THE AQUANODE CONTROLLER

If your system includes a modem, X-10 control interface or satellite modules, be sure that these components are plugged in BEFORE powering up the AquaNode.

Plug the end of the cable from the power transformer into the power jack located on the bottom left of the AquaNode (See Figure 2.19). Be sure to use the protective power cord drip loop to prevent water from running down the cord into the AquaNode controller. The cord should extend below the outlet so that any runoff will not enter the electrical outlet.

When the controller is first plugged in, it goes through a diagnostic self check. The



Use of any cable other than that supplied by Aquadyne may result in an incomplete connection or, in extreme cases, damage to the AquaNode or computer.

The cable utilized for Direct Cable connection is a non-standard cable. It can be ordered from your dealer or from Aquadyne.

LCD screen will show a series of messages indicating that a self diagnosis is in progress, as shown in Figure 2.20.

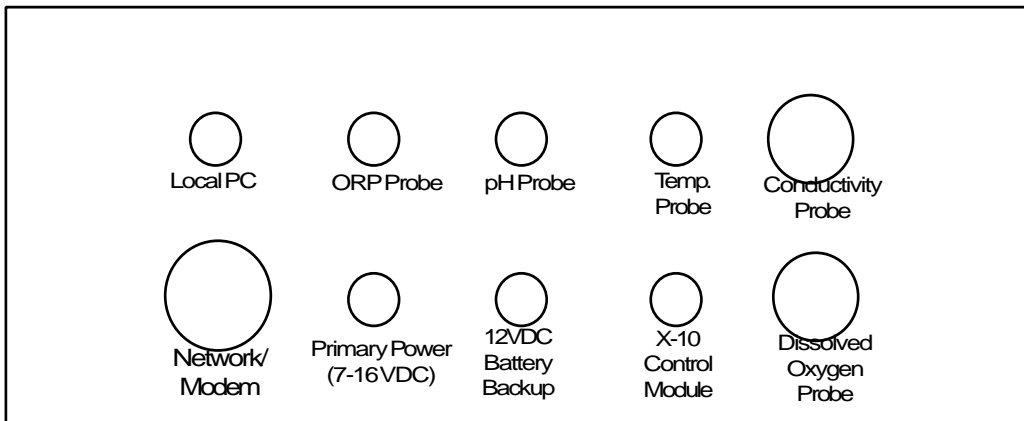

Figure 2.19 • Bottom View of the AquaNode XL Controller

Installing the Components

When powering the AquaNode for the first time, make note of your system serial number and H₂O/S software version. This information is required should you find it necessary to obtain technical support. When the current status screen begins to display you will notice that the top line of the display will show the current probe readings. The second line will show system activity such as systems being activated, and alarms occurring. When the Current Status Screen is shown, Figure 2.21, you are ready for programming the AquaNode controller.

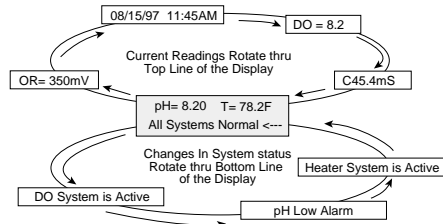

Figure 2.21 • Current Status Window

STEP 8—INSTALL THE 12-VOLT BACKUP BATTERY PACK

The 12V battery backup consists of a 12VDC Gell cell with a charger and cable assembly. The battery charger is required since the AquaNode will not charge the gel cel. It will also insure that the battery is kept in a fully charged state should a power failure occur. The 12 V battery backup is not provided by Aquadyne. Figure 2-22 shows the connection between the AquaNode, battery backup and charger system.

Place the gel cell in a location near the AquaNode. Plug the harness into the Battery Backup connector on the bottom of the AquaNode. Plug the charger into a powered AC outlet. To test the backup system unplug the primary power source. The status line should indicate that the unit is operating on battery power and provide a battery voltage indication.

CONGRATULATIONS—You have now completed the first half of the AquaNode installation—components installation

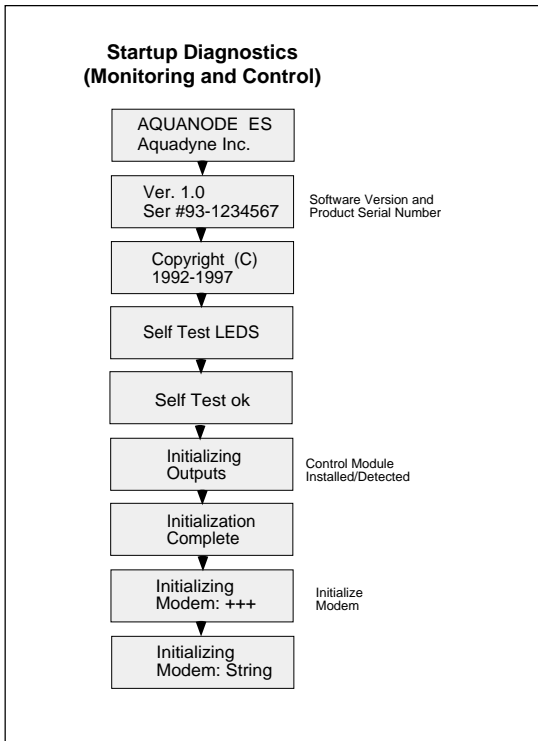

Figure 2.20 • Startup Diagnostics

Installing the Components

In Steps 1-8, you mounted the AquaNode and installed the following components:

- Probes (Temperature, ORP, pH, Conductivity, and Dissolved Oxygen),
- Aux. I/O Module and Device (optional),
- X-10 Control Module (Optional),
- Satellite Module(s) (Optional), and
- Communications Equipment (Optional).

You then powered up the AquaNode and installed the Backup Battery Pack.

You are now ready for the second half of the installation process: programming the AquaNode H₂O/S software (Steps 9-25), presented in Chapter 3.

Don't worry, you don't have to be a computer programmer to successfully program the AquaNode. We not only give you the roadmap (the Menu Map), we guide you down the road as well.

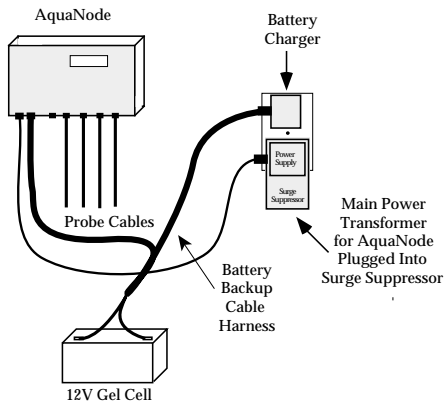

Figure 2.22 • Battery Backup Installation

Chapter

3

**Programming
the
Software**

Programming the Software

PROGRAMMING THE SOFTWARE

Your AquaNode includes the latest version of the H₂O/S software which was pre-loaded into FLASH memory at the factory prior to shipment. The FLASH memory design of the AquaNode allows future software upgrades to be installed by the user as they are made available by Aquadyne.

For additional information pertaining to the latest software release, visit our WEB page: <http://www.aquadyne.com>

For this part of the installation process, we recommend that you have your laminated Quick Reference Menu Map card at hand to follow along with the description. This will familiarize you with the Quick Reference card as well as introduce you to the use of the AquaNode software menus. Detailed Menu Maps are given in Appendix A.

Before you begin entering setpoint data, we thought it would be beneficial to review the general structure of the AquaNode menus.

Overview of the AQUANODE Menus

All software menus and data entries are viewed through the LCD Screen Window on the face of the AquaNode (Figure 3.1). The screen typically shown in the window is the Current Status Screen. This screen gives current probe readings for each of the five parameters: conductivity, temperature, pH, ORP, and Dissolved Oxygen (DO).

Top Level Display

The Current Status Screen is only one of several screens that comprise the Top Level Display. Side One of the Quick Reference



Figure 3.1 • Face of AquaNode XL

Menu Map shows all available Top Level Displays.

To scroll through the Top Level Display, simply push the right or left arrow on the keypad. The screens will be shown in the order indicated on the Menu Map. You can cycle through the screens as many times as you desire in either direction.

The Top Level Display provides both current parameter information (i.e. pH, ORP, DO, Conductivity, and Temperature) on the top line and system status on the lower one. As systems are activated or alarms are triggered the status line provides up to date status on the system being managed. As events occur they are entered into the lower display. Up to 16 events are saved and displayed in sequence. Figure 3.2 shows the current status window.

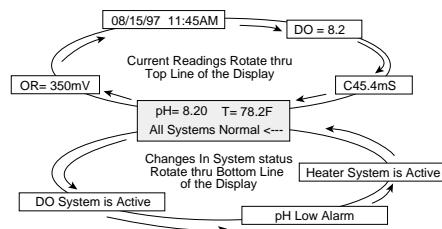

Figure 3.2 • Current Status Display

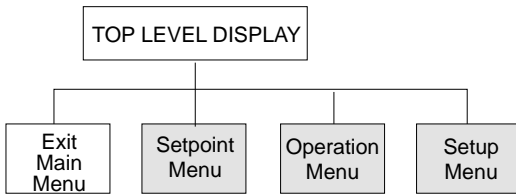

Figure 3.3 • The Main Menu

Main Menu

The Main Menu is comprised of three primary sub-menus, as shown in Figure 3.3

- Setpoints Menu
- Operation Menu
- Setup Menu

These menus are the first level down from the Top Level Display and comprise the Main Menu for the AquaNode. This menu is the doorway to all other sub-menus. To enter the Main Menu, simply push the Enter key from any position on the Top Level Display.

Note that from the Top Level Display you will always enter the Main Menu at the same place: the Setpoints Menu.

From there, you can scroll left or right in the Main Menu as desired, using the right or left arrows on the keypad.

Setpoint Menu Overview

As the name implies, the Setpoints Menu allows you to enter the setpoint values for the five water quality parameters:

- Temperature Setpoint
- ORP Setpoint

- pH Setpoint
- DO Setpoint
- Conductivity Setpoint

For Monitoring and Control Systems, in addition to setpoint values, you can input parameter setpoint ranges, and parameter control information for use with the internal relays or X-10 control system.

Operation Menu Overview

The Operation Menu includes options that might be required in day-to-day operation of the AquaNode:

- System Control
- Probe Calibration
- Lock/Unlock Password
- Clean Probes
- Printer Menu

Setup Menu Overview

The Setup Menu is used primarily during initial setup of the AquaNode controller, including:

- System Test
- Set Control Addr
- New Password
- Temp Scale
- Timers
- Alarm
- Data Logger

Programming the Software

- Wave-Maker
- Filter
- Pager (optional)
- Dissolved Oxygen
- Conductivity
- Digital Inputs
- Scroll to the right using the right arrow key until you reach pH Setpoint. Then press Enter.
- You will then be at pH Setpoint. Move the arrows left or right to find the desired pH value. Then press Enter to record the Setpoint value into memory.

Using the Menu Map—An Example

Suppose, for example, you wish to enter the pH setpoint for the AquaNode controller. To do this, you would follow these steps (See Figure 3.4):

- From anywhere on the Top Level Display, press Enter. This will take you to the Setpoints Menu.
- Press Enter at the Setpoints Menu. This will take you to the Setpoint prompt. Press Enter again and you will be at Temperature Setpoint.

Remember that the Main Menu selections are the doorway through which all other sub-menus are accessed. From the Top Level Display, press the Enter key to get to the Main Menu level. Then simply scroll to the left or right, as desired.

Initial Software Setup

You can now begin programming the AquaNode H₂O/S software—developed by Aquadyne specifically for advanced water quality monitoring applications. The H₂O/S software setup consists of Steps 9-23 in the installation process. A summary of these steps is given in Table 3.1. Step 15 (Entering Setpoint Values) is perhaps one of the most important of these steps.

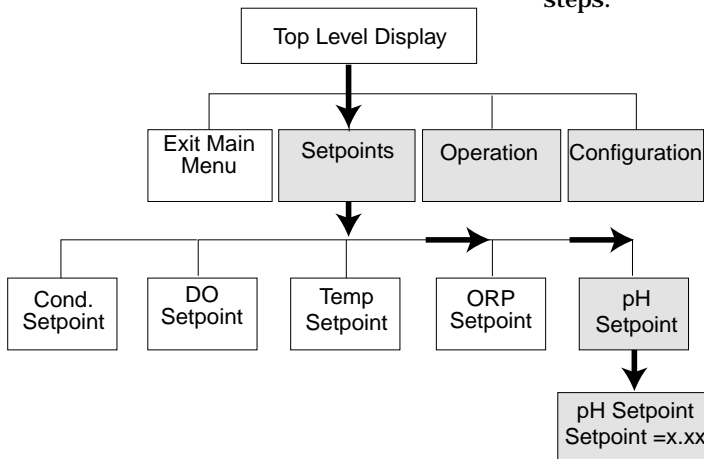

Figure 3.4 • Entering pH Setpoint

Programming the Software

Initial Software Setup	On Menu	Monitoring System	Monitoring & Control System
9. Set System Clock	Setup	X	X
10. Enter Password	Setup	Optional	Optional
11. Set Noise Filter Control	Setup	X	X
12. Select the Conductivity Temp. Compensation Settings	Setup	X	X
13. Select a Temperature Scale	Setup	X	X
14. Select DO Operating Mode (YSI Probe Only)	Setup	X	X
15. Enter Setpoint & Range Values (Cond., Temp., pH, ORP, DO)	Setpoint	X	X
16. Enter the Alarm Range Values & Hold-Off Timer	Setup	X	X
17. Set Up Digital Inputs	Setup	N/A	X
18. Set Up Lighting System	Setup	N/A	X
19. Set Up WaveMaker System	Setup	N/A	X
20. Assign Satellite ID's on Software	Setup	N/A	X
21. Set Up the Communications Software	Setup	X	X
22. Enable AquaNode System Control	Operations	N/A	X
23. Test the System Configuration	Setup	N/A	X

Table 3.1 • Initial Software Setup

STEP 9—SET THE SYSTEM CLOCK (SETUP MENU)

The AquaNode is equipped with an internal clock that includes its own battery source. So, you won't need to set the clock as a result of power failure. However, because each clock is set from the factory with Pacific Standard Time, you may need to adjust the clock to your time zone. Control of the clock is accessed under the Setup Menu under Timer.

Your first option in setup is to load the current date. Data is loaded in the following order: First, the month (01=January, 02=February. . . , 12=December), then the day of the month, and finally the last two digits of the year. To enter the year 1997, you would only enter "97." For example, if the current date were May 16, 1997, then you would enter "05/16/97." The controller will then prompt you to verify the date before continuing to enter the time. If you answer NO to the question "Correct?," then you have an opportunity to re-enter the date.

Programming the Software

Next, enter the time in a 12-hour format. After the time is entered you are again given the opportunity to verify that what you entered is correct. If you answer NO, then you will be given another opportunity to enter the time.

STEP 10—ENTER THE PROTECTIVE PASSWORD

The use of a password will protect your controller from unauthorized use. Anyone attempting to use the controller will not be able to enter the Main Menu without entering the correct password. Your password may consist of up to five characters, letters and/or numbers. You may choose not to utilize the password protection; if so, do not enter any password and move to the next setup procedure.

Many people find password numbers easier to remember; you may want to choose a number you already use somewhere else, such as an address. To enter your password, go to the "New Password" selection in the Setup Menu.

When you press Enter, you will be prompted to enter your password of up to five characters. To do so, push the arrow until the first character you desire appears, then push enter. Follow this process for the remaining

characters of your password. If your password has less than five characters, push enter a second time to signal that your password is complete. You will be prompted to enter the same password a second time to ensure that the password has been entered correctly. When your password has been entered and verified the LCD Screen returns to the "Exit Password" Screen.

In order to activate your password selection go to the Operations Menu, press Enter, then scroll using the arrows to the "Lock-Unlock" menu. Push Enter and the display will show "Lock Now." Push Enter and you have activated the password.

STEP 11—SET THE NOISE FILTER CONTROL

The AquaNode comes with a software noise filter which minimizes the effects of electrical noise on probe measurements. The filter may be set to one of four states: Off, Low, Medium, or High. Unless your AquaNode is having problems recording data into the data-log, we recommend an initial setting of Off. If your aquatic environment is stable, but your HP hand-held printer output is showing unusual "high-low" readings, then some adjustment to the filter setting is warranted. It is always advisable to first identify and eliminate the source of the interference —before attempting to use the filter to achieve the same goal. The filter menu is accessed under the Setup Menu.

Note that the noise filter does not alleviate the satellite control problems associated with electrical noise. Contact your nearest X-10 control module dealer who can help troubleshoot installation problems.



Note

Entering "AQDYN" at the new password prompt will display the system serial number and the version of H₂O/S software installed in the AquaNode. This information may be required should you need to contact technical support for any reason.

STEP 12—SELECT THE CONDUCTIVITY TEMPERATURE COMPENSATION SETTINGS

Temperature variations affect conductivity readings. Therefore temperature compensation is one of the sub-menus for the conductivity setup. This setpoint allows you to artificially adjust the conductance reading in percent per degree Celsius (s.s%/°C). As a general rule, an adjustment of 2-3% is common for the water environment.



Note

The conductivity range is selected automatically when you plug the conductivity probe into the AquaNode. Two probes are available from Aquadyne for the AquaNode. A low range probe (0-2000 μ S) and a high range probe supporting (0-200ms). This is important since the conductivity range of water varies greatly depending on the application. Saltwater, for example, ranges from about 45,000 to 55,000 μ S, whereas freshwater conductivity is typically between 800 and 1,500 μ S, depending on the water source. Hydroponic and other applications can vary across a broad range as well, depending on the crop and the stage of growth.

The first scale is a much more sensitive scale since it reflects changes in conductivity of only two microSiemen (1 μ S). The second scale is less sensitive and reflects conductivity changes in increments of 100 μ S.

To reach the temperature compensation menu (“Temp Comp Menu”), press Enter on the Setup Menu, then press the arrow keys until you scroll to the Conductivity menu (Cond. Menu). When you press Enter again, you will be at the Temp Comp Adjust Menu.

NOTE: You can test the required percent adjustment setting by using water temperatures of known conductivity value and observing the conductivity readings. The readings should stay constant.

STEP 13—SELECT A TEMPERATURE SCALE

The temperature scale menu allows you to select the scale you wish to use for temperature measurement—Celsius or Fahrenheit. The AquaNode controller is set to Fahrenheit at the factory.

Changing the temperature scale automatically recomputes your setpoints. For example, if your setpoints were entered in Fahrenheit and you change the temperature scale to Celsius, all of your setpoints will be automatically converted to their Celsius equivalents.

The Temperature Scale Menu is accessed by pressing Enter at the Setup Menu. Use the directional keys to scroll through the menu options until the temp scale menu is reached. Press Enter to access the item, and use the directional keys to choose a temp scale.

Programming the Software

STEP 14—SELECT DO PROBE MODE (YSI PROBE ONLY)

The DO system can be operated in either a continuous or sampled mode. In continuous mode the DO probe is taking measurements 10 times per second all the time. In the Sampled Mode the DO system is powered down for 2 minutes. The probe is then powered back up for 75 seconds. Data is sampled during the last 15 seconds of the powered cycle. The entire cycle is then repeated. To extend the time between probe servicing and calibration the DO system should be run in a sampled mode. Caution should be exercised when running a controlled application since systems will only be managed during the 15 seconds that the AquaNode is sampling the DO levels in the system. The Sampled ON time and OFF times can be changed in the menu as well if desired.

The DO probe mode is located in the Setup Menu in the DO sub-menu. (See Appendix A)

STEP 15—ENTER SETPOINT AND RANGE VALUES

Various setpoints and ranges must be established for each of the five monitoring parameters: conductivity, temperature, pH, ORP and DO.

There are three values that must be entered:

- The optimal setpoint value (in Step 15).
- The control range (in Step 15).
- The alarm range (in Step 16).

When these three values are entered, the system will operate as illustrated in Figure 3.5. As long as the water quality parameters remain within the acceptable operating range, no control or alarm will be activated. If, however, the parameter rises above or falls below the acceptable operating range, the AquaNode will activate the appropriate control device. The control device remains in operation until the parameter returns to the Setpoint value. (For ORP, the control device remains in operation until the ORP value returns to the HIGH control point.)

Entering Data on the Setpoints Menu

Generally speaking, you enter or change any setpoint by first pressing Enter from any position on the Top Level Display. This will bring you to the Setpoints Menu. Press Enter and you will be at the "Temp Setpoint" menu. Scroll left or right using the arrows until you arrive at the desired parameter. Press Enter. When the current setpoint is displayed, push

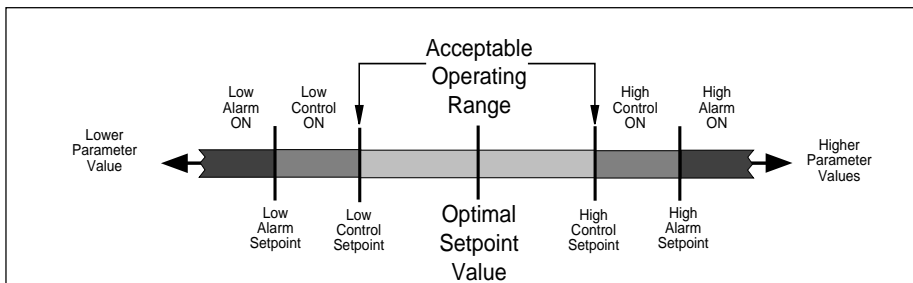

Figure 3.5 • Monitoring and Control Systems Setpoint and Ranges

ON SETPOINT MENU		
Value Required	Monitoring System	Monitoring & Control System
Conductivity		
Conductivity Setpoint	X	X
Conductivity Range	X	X
Low Conductivity Dose Time		X
Low Conductivity Dwell Time		X
High Conductivity Dose Time		X
High Conductivity Dwell Time		X
Temperature		
Temperature Setpoint	X	X
Temperature Range	X	X
pH		
pH Setpoint	X	X
pH Range	X	X
Dose Time		X
Dwell Time		X
CO ₂ Doser Time		X
CO ₂ Dwell Time		X
ORP		
ORP Setpoint	X	X
DO		
DO Setpoint	X	X
DO Range #2	X	X
DO Range #1	X	X

Table 3.2 • Parameter Setpoints

the right arrow to increase the value or the left arrow to decrease the value. Once the setpoint value you want is displayed, push Enter once to register your selection. Table 3.2 shows which parameters need to be set for monitoring and alarming functions and the additional settings needed for adding control.

As you choose a setpoint value, check the System Status light. The light should be solid green. If the light turns yellow as you are selecting your value, the setpoint is out of the normal value range for that parameter. Adjust the setpoint accordingly.

Conductivity Setpoints

To enter the conductivity optimal setpoint value, press Enter from any place on the Top Level Display.

Using the left arrow key, scroll to the conductivity menu and press Enter. At the flashing screen, scroll to the left or right until the desired conductivity value appears and press Enter. This registers the optimal conductivity setpoint value.

In a control application, in addition to optimal setpoint value you will need to enter a range value as well, in addition you will need to enter other values in the Setpoints Menu including dosing times for low and high conductivity, and dwell times.

A dwell time is the length of time that the AquaNode will wait until dosing can occur again. This feature prevents overdosing a system with a dosing solution and protects against “short cycling” of equipment.



Note

Configuration data such as setpoint values, are stored in permanent (nonvolatile) memory. Should primary or backup power to the AquaNode be lost, the setpoint values will be restored to their previous values when power is restored to the Octopus.

Conductivity Example

Suppose that you desire an optimal setpoint value of 45 mS, an operating range of ± 5 mS and an alarm range of ± 3 mS. Figure 3.5 illustrates the relationship between the optimal setpoint value, and the control range.

For these systems, if the conductivity value remains within the target operating range, the parameter status light will not be illuminated. If the conductivity value enters the control range, the parameter status light will turn either red if the low conductivity dosing system is enabled, or green if the high conductivity dosing system is active. If the parameter status light is flashing red, the low conductivity dosing system is in a dwell state. A high conductivity dosing system dwell state is indicated by a flashing green parameter status light (See Figure 1.2).

Temperature Setpoints

The temperature setpoint defines the optimum water temperature. In a control application you will also need to enter the control range on the Setpoint Menu.

To enter the temperature setpoint, first press Enter from any position on the Top Level Display. You will be at the Setpoints Menu. Press Enter and you will be at the Temperature Setpoint Menu.

When you press Enter again the current temperature setpoint will begin flashing on the LCD display window. Pushing the right arrow will increase the setpoint value and pushing the left arrow will decrease the setpoint value. When the desired value is displayed, push the Enter key to select it.

If the system is configured for monitoring and control, you will need to enter values for the temperature range in addition to the temperature setpoint. This determines the control range for heating and chilling devices.

Since most heaters and chillers have their own thermostat, these thermostats can be used as a backup temperature control system. The heater thermostat should be set several degrees above your desired temperature and the chiller several degrees below. If your desired temperature is 78°F then set your heater thermostat at 81°F and your chiller thermostat at 75°F.

Temperature Example

Suppose you have a Monitoring and Control System and that your setpoint value is 78.2 °F, your target operating range is ± 0.1 °F, and the alarm range is 0.1 °F. (Figure 3.5 illustrates the relationship between the setpoint value, and the control and alarm ranges.)

If the temperature stays within the target operating range (78.1–78.3 °F), the parameter status light will remain off.

If, however, the temperature enters the control range (between 78.1°F on the low side and 78.3°F on the high side), the parameter status light will either turn green if the chilling system is active, or red if the heating system is active.

At the beginning of the control range, the AquaNode will turn on the chiller or heater, as required. These peripheral devices will remain activated to drive the temperature value back to the optimal setpoint value, and once achieved, the peripheral device will be turned off.

pH Setpoints

The pH setpoint defines the optimum pH level that you wish the AquaNode controller to maintain in the aquatic environment. To enter a pH optimal setpoint value, press Enter from any place on the Top Level Display. Press Enter and use the right arrow to reach the pH Setpoints Menu. When you press Enter, the current pH setpoint will flash on the LCD display. Push the right arrow to increase the setpoint value or the left arrow to decrease the setpoint value. When the desired value is displayed, push Enter to register your selection. Other setpoint values are entered similarly. For controlling pH additional values must be entered on the Setpoints Menu, including the dose and dwell values.

The AquaNode can control the pH system by dosing a buffer solution or injecting CO₂ gas or do both.

The pH control range is selectable from ± 0.05 pH units to ± 1.00 pH units, and determines the ON points for the pH and CO₂ dosing systems.

The Current Dose in minutes (time per dose of buffer solution) will flash on the screen. This is the number of minutes that the AquaNode controller will dose buffer to bring the pH level back up into the target operating range. The acceptable values for buffer solution dosing are from 1 to 99 minutes.

Dose times will range from 0-99 minutes. You are also required to enter a dwell time— The Dwell Time is the length of time that the AquaNode will wait until dosing can occur again. This feature prevents overdosing a system with buffer.



Note

Note that if the dose time is set to 0, the dwell time entered will be ignored by the AquaNode and the unit will continue to dose buffer until the pH returns to the Optimal Setpoint Value.

The next option is the setting of the CO₂ Dosing, in seconds. This controls how long the CO₂ gas valve will remain open. The possible values range from 0 to 99 seconds. For example, if you enter 10 seconds, when the upper end of the target operating range for pH is reached, the AquaNode will turn on the CO₂ gas for 10 seconds to reduce the pH to a lower value. A CO₂ Dwell Time will force the AquaNode to wait to allow the gas to be absorbed into the water. This will prevent the pH value from dropping too fast.

If you enter a value of 0 seconds, then the AquaNode will turn the gas valve on when the pH level reaches the high end of the target operating range and will keep the valve open until the pH drops below the optimal pH level. The 0 seconds option is for systems with pressurized CO₂ injection.

Dose Time	CO ₂ System
0 Sec.	Pressurized Systems
1-99 Sec.	Non Pressurized Systems

Table 3.3 • Buffer Dose Time

The last pH control selection is the CO₂ dwell time. This is the time that the AquaNode waits before allowing another CO₂ gas injection to occur. This time is selectable from 1-255 minutes.

Programming the Software

If the AquaNode senses that the pH is outside of the target operating range, it will turn on the pH doser or CO₂ injector until the pH returns to the optimal setpoint range (See Figure 3.5).

An green parameter status light indicates the CO₂ dosing system is active, while an redstatus light indicates the pH dosing system is active

A CO₂ dwell time is indicated by a flashing green status light while a flashing redlight indicates a pH dosing system dwell time.

ORP Setpoints

The ORP setpoint defines the acceptable level of oxidation reduction potential in the aquatic environment. The ORP level is an indicator of ozone. Acceptable levels are between 0 and 450 mV. The ORP setpoint can be maintained through the use of an ozonizer in Monitoring and Control System. However, unlike the proceeding parameters, the ORP setpoint has a FIXED range of ± 5 mV.

DO Setpoints

The DO setpoint defines the optimum DO level that you wish the AquaNode controller

to maintain in the aquatic environment. To enter a DO optimal setpoint value, press Enter from any place on the Top Level Display. Press Enter and use the right arrow to reach the DO Setpoints Menu. When you press Enter, the current DO setpoint will flash on the LCD display. Push the right arrow to increase the setpoint value or the left arrow to decrease the setpoint value. When the desired value is displayed, push Enter to register your selection.

The DO system uses a more advanced control system employing two control ranges instead of just one as in the other systems (See Figure 3.6). The dual range design allows you to change the way oxygen levels are managed in the system if the DO level move out of the first range and into the second. This provides the ability, for example to use a air injection system (controlled by range 1) to maintain DO levels for the first range and pure oxygen injection system (controlled by range 2) as a backup should the DO levels continue to fall. The DO control range is selectable from ± 0.1 ppm/mL units to ± 19.9 ppm/mL. Range 1 and Range 2 are both selectable from ± 0 ppm/mL units to ± 1.0 ppm/mL. Figure 3.6 depicts the DO control system in the AquaNode.

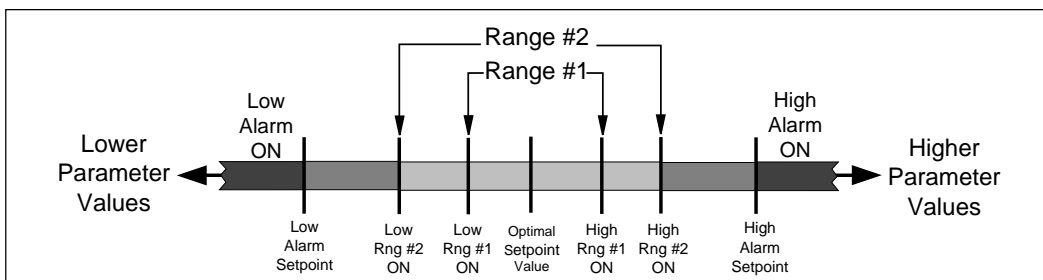

Figure 3.6 • Dissolved Oxygen Dual Range Control

If the AquaNode senses that the DO level is outside of the operating range #1 it will turn on the Range #1 control system. If the DO level continues to move outside of operating range #2 then Range #2 control system will activate.

The DO readings can be displayed in either ppm or % Saturation. This is selected in the Setup menu under Dissolved Oxygen Menu. The AquaNode is capable of readings from 0 to 199% Saturation.

Verify All Setpoint Settings

You can easily view the parameter setpoints. From the Top Level Display, simply push either the right or left arrow keys to scroll through the screens. Each successive push of an arrow will display another setpoint until it returns to the current status screen. Push Enter to at any time to enter the other menu's.

STEP 16—ENTERING ALARM RANGE

General Alarm System

The alarm is located in the Setup Menu under Alarms. All alarm ranges are entered in this menu. The alarm range can only be entered if the alarm system itself is also enabled first. In addition to an alarm range for each system there is a common alarm hold-off time which can be entered. This will prevent any system for generating an alarm until the hold off time has expired. Table 3.4 lists all system parameters that are located in the Setup menu relating to alarming or system configuration.

When a alarm occurs the status line on the LCD screen will show which system(s) had the alarm and whether the alarm was a high or

ON THE SETUP MENU		
Value Required	Monitoring System	Monitoring & Control System
Conductivity		
Temperature Compensation	X	X
Conductivity Alarm Range	X	X
Temperature		
Temperature Scale	X	X
Temperature Alarm Range	X	X
pH		
ph Alarm Range	X	X
ORP		
ORP Alarm Range	X	X
DO		
DO Alarm Range	X	X
DO Sampling Mode (YSI)	X	X

Table 3.4 Parameter Settings Included in the Setup Menu

low alarm condition. When the hold-off time has expired the controller will generate an audible alarm and initiate a alarm page if the pager system is enabled on the controller. The alarm condition is reset by pressing the Enter button on the front of the controller. Pressing the Enter key during an alarm will stop the audible alarm and cancel any pending pages but the alarm status messages will NOT be cleared until the alarm condition is no longer sensed by the controller.¹

G1 and G2 Alarm Logic

The G1 and G2 alarm outputs are two additional alarm outputs available with the AquaNode XL controller. Any parameter (pH,

Programming the Software

ORP, Temperature, Conductivity, or Dissolved Oxygen) can be added to either one or both of the G1 and G2 outputs by selecting ENABLE under each parameter in the Alarm Menu (refer to the Alarm Menu menu map, Appendix A-11).

All parameters enabled in G1 will be OR'ed together to create a custom alarm output. For example let's say conductivity and dissolved oxygen have been enabled in G1. If either conductivity or dissolved oxygen is in an alarm state, G1 will have an output. The G2 alarm output behaves similarly. Remember to enable the general alarm output (the first enable/disable choice) for any parameter you wish to add to G1 or G2

Both the G1 and G2 alarm outputs are addressed (refer to the Set Cntl (Control) ID Menu, Appendix A-8 in the same fashion as the General Alarm output.

Conductivity Alarm

The conductivity alarm range is entered in the Setup Menu under the Alarms sub-menu. From the Setup Menu, press the Enter key. Then press the right or left arrow until you reach the alarm menu. Press the Enter key and you will go to the pH menu. Scroll left using the arrows until you get to "Cond Alarm." Press enter and then select Enabled and press Enter again. You will automatically be directed to the conductivity alarm range menu.

As long as the conductivity value of the water stays outside the alarm range, (i.e. within the acceptable operating range or control range), the alarm will not be triggered.

If the conductivity value goes outside the control range, an alarm will be triggered. The alarm condition will be confirmed by an alarm status message appearing in the LCD screen, the sounding of an audible alarm, and the issuance of a pager alarm (if installed), once the hold-off period has expired. (See Figure 3.5)

In addition to the general conductivity alarm there is also two separate conductivity alarm outputs which can be configured in the Set Cntl Address menu. One for a low conductivity alarm and the other for a high conductivity alarm. These outputs will go active in a low or high conductivity alarm condition.

Temperature Alarm

The temperature alarm range can be set from ± 0.10 degrees to ± 2.00 degrees. The temperature alarm range can only be set if the temperature alarm is enabled.

An alarm will be triggered when the value measured falls outside of the control range.

For example, suppose you have a Monitoring Only system with an optimal temperature setpoint value of 78.0 °F and an acceptable operating range of ± 0.1 . Figure 3.5 illustrates the relationship between the setpoint value and the acceptable operating range. When the parameter value stays within the acceptable operating range (77.9–78.1 °F), the system monitoring function will not detect an alarm and the parameter status light will be off.

If, however, the temperature drifts past the acceptable operating range (below 77.9 °F or above 78.1 °F), an audible alarm will be triggered, the monitored parameter will begin flashing on the current status screen, and a

pager alarm will be issued (if installed), upon the expiration of the hold-off period.

As a second example, suppose you have a system with the same values as above but with a temperature range of $\pm 0.2^{\circ}\text{F}$. If the temperature value drifts away from the target operating range and comes to the control range (lower than 77.8°F or higher than 78.2°F), then the peripheral device (heater or chiller for example), will be activated. If the temperature continues to drift away from the target operating range and comes to the end of the control range (i.e. $<77.7^{\circ}\text{F}$ or $>78.3^{\circ}\text{F}$), then the heater or chiller will remain active but an audible alarm will be triggered, the monitored parameter will begin flashing on the LCD display window, and a pager alarm will be issued (if installed), upon expiration of the hold-off period.

pH Alarm

The pH alarm range is entered in the Setup Menu. Note that the pH alarm range can only be set if the pH alarm is enabled and it is expressed as a value around the pH setpoint. The pH alarm range value can be set from ± 0.05 to ± 1.0 around the setpoint and is adjustable in increments of 0.05 pH units.

To reset the alarm you must push the Enter key on the front of the AquaNode once. This action will silence the alarm. When the parameter returns to the acceptable operating range, the alarm will not re-trigger until the parameter again goes outside the acceptable operating range.

There is a target control range in addition to the alarm range. For example, suppose your system has an optimum setpoint pH of 8.3 and a target operating range of ± 0.10 , then the pH has a target operating range from 8.2

to 8.4 pH units. If you set the pH alarm range to ± 0.20 pH units, an alarm will be triggered if the pH falls below 8.0 or rises above 8.6 pH units. If the hold-off timer value is greater than zero, the audible alarm will not sound until the alarm hold-off timer has expired.

ORP Alarm

The ORP alarm range can be set from ± 5 mV to ± 100 mV. The ORP alarm range can only be set if the ORP alarm is enabled. If the Hold-off Timer value is greater than zero, the audible alarm will not sound until the alarm Hold-off Timer has expired.

To reset the alarm you must push the Enter key once on the face of the controller. This action will silence the alarm and the alarm will not re-trigger until the measured value again falls outside the alarm range.

For example, to maintain a ORP of 200 mV. This means that the ORP has an acceptable value range from 195 mV to 205 mV (remember, ORP has a default range of ± 5 mV.) If you set the ORP alarm range to ± 10 mV an alarm will be triggered if the ORP falls below 185 mV or rises above 215 mV.

DO Alarm

The DO alarm range can be set from 0 to ± 1.0 p.p.m. The DO alarm range can only be set if the DO alarm is enabled. If the Hold-off Timer value is greater than zero, the audible alarm will not sound until the alarm Hold-off Timer has expired.

A status message 'DO High Alarm' or 'DO Low Alarm' will be displayed in the status line on the LCD screen during a DO alarm condition.

Programming the Software

Set the Alarm Hold-off Timer

The Hold-off Timer provides a delay before an audible alarm is sounded and before the remote Alarm Satellite (if the system includes it), and an alarm page is sent (if installed). This is useful to avoid “bounce” by allowing sufficient time for the trend to fully establish itself. The timer can be set from 0 minutes to 99 minutes. If you select 0 minutes then no delay will occur before a audible alarm is triggered, Alarm Satellite is turned on, and a page is generated (if installed).

If the Hold-off Timer value is greater than zero, the audible alarm will NOT SOUND until the alarm Hold-off Timer has expired. The Temperature Screen will flash whenever the measured value is outside of the alarm range. This is useful to determine which system has triggered the alarm. To reset the alarm you must push the Enter key once on the face of the AquaNode. This action will silence the alarm and the alarm will not re-trigger unless the temperature value returns to the target operating range and then reaches the alarm point again.

STEP 17—SET UP DIGITAL INPUT

The software in the AquaNode unit (H₂O/S) will support 2 digital input alarm's on either a switch open condition or a switch close condition. A selectable wait period (3 minutes is the default setting) is also provided to prevent false alarm conditions.

Note: If you are using Input #2 as a Aux. Analog input then the input control for digital input #2 must be set to NO ALARM.

The menu is called "Digital Inputs" and is located in the Setup menu. When you enter



Note

The reliability of the digital input circuit is dependent on the use of low impedance switches and wiring. For customers wiring multiple switches in series, the total resistance of the switches should not exceed 200 ohms.

the menu you are presented with Digital Input 1 or 2. Pushing the button again gets you to the following.

No Alarm

Alarm is disabled.

Alarm when Closed

The alarm will sound and a message 'Input Alarm 1 or 2 will be displayed in the top display status line. A page (if enabled) will also occur after the hold-off when the two contacts are CLOSED.

Alarm when Open

The alarm will sound and a message 'Input Alarm 1 or 2 will be displayed in the top display status line. A page (if enabled) will also occur after the hold-off when the two contacts are OPEN.

Hold-off

Hold-off is the number of seconds that the system will wait before generating an alarm. The Digital Input port allows the AquaNode to issue an alarm based on whether a switch has opened or closed. The purpose of the hold-off time is to allow the measured

parameter to “settle” into an alarm zone—thereby avoiding the premature processing of a false alarm. The hold-off time is selectable from 0 to 999 seconds. If the hold-off time is set to “0”, the AquaNode will generate an alarm condition as soon as the switch opens or closes. The most common application this is used for is to detect high or low water levels using a float switch.

STEP 18—SET UP THE LIGHTING SYSTEM

The setup of the light timers involves setting a start time and a stop time. The start time is the time the lighting system will come on and the stop time is the time it will go off. Only one start and one stop time can be set for each channel.

To enter start and stop times, go to the Setup Menu, press Enter, then use the arrow keys to scroll to “Timers Menu.” Once at the timers menu, press Enter. Use the directional keys to scroll through the menu options until you reach the general timers menu. Push Enter to select.

Use the direction key to select the desired timer and push Enter.

STEP 19—SET UP THE WAVEMAKER SYSTEM

Changing flow patterns in an aquatic environment might be desirable to stimulate the growth of aquatic life, or to improve circulation.

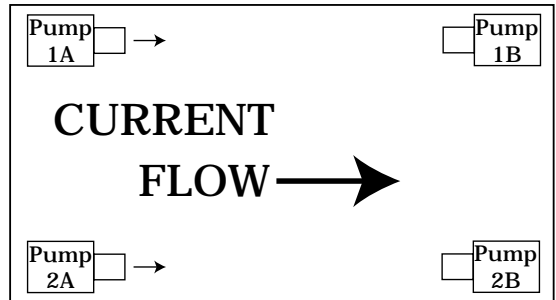

Pumps 1A & 2A Operating

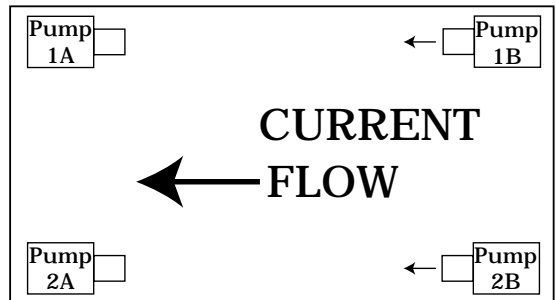

Pumps 1B & 2B Operating

Figure 3.7 • WaveMaker System

Setting up the WaveMaker Timers

Each WaveMaker timer has a duration period. The duration specifies the length of time the specified timer (i.e. pump 1A) will operate before turning off and going to its counterpart timer (i.e. pump 1B). The programming of the wave timers is accessed under the Setup Menu.

The WaveMaker system is comprised of two completely independent systems. System 1

Programming the Software

has two pumps (Pump 1A, Pump 1B), and System 2 has two pumps (Pump 2A, Pump 2B), as shown in Figure 3.7. Pumps 1A and 1B work as a pair (when one is on the other is off, and vice versa). And Pumps 2A and 2B also work as a pair. Figure 3.7 shows just one WaveMaker example:

Cycle 1: (Top Diagram)

Pumps 1A and 2A are set to operate for 3 minutes (variable), with Pumps 1B and 2B off. This produces a flow pattern from left to right.

Cycle 2: (Bottom Diagram)

Pumps 1B and 2B are set to operate for 5 minutes (variable) with Pumps 1A and 2A off. This produces the flow pattern from right to left.

Since the pumps can have multiple ON/OFF times, and can operate independently, there is a great deal of flexibility in wave and surge generation.

STEP 20—ASSIGN SATELLITE IDS

Step 5 in the installation process (given in Chapter 2) was to install and address the satellite modules or to connect up contactors to the built in relays. As described in that section, each satellite has a unique address (Satellite ID). In the case of the X-10 system. In addition to setting the IDs on the face of the satellites, the same Control ID's must also be assigned in the AquaNode controller software. For each satellite module, enter its address in the software. (Set Cntl Address is accessed under the Setup Menu.) The address selected controls whether the X-10 control system is used or the two internal relays are selected. Addresses A thru P in

1 2 3	9 9 9 9 9 9
Serial Number	Alarm Code

Table 3.8 • Alarm Code on Pager

the Set Control Address (Set Cntl Addr) menu select the X-10 system while selecting an address starting with 'R' selects the internal relays. If the internal relays are used then a valid address for relay #1 is 'R-1' and relay #2 is R-2.

Other Control IDs

In addition to Satellite ID's for peripheral devices such as heaters and chillers, Satellite ID's may be required for other devices such as X-10-activated remote alarms configured in the system. Don't forget to assign Satellite ID's to the following, if applicable:

- Remote Alarm
- Lighting Timers
- WaveMaker

STEP 21—SET UP THE COMMUNICATIONS SOFTWARE

Setting up the communication software involves two steps:

- Setting Up Alarm Pager software (in AquaNode Software)
- Setting Up AquaWeb Application (in PC Software)

	pH	ORP	Temp	Cond	DO	IN1	IN2
Low Alarm*	1	1	1	1	1	1	1
High Alarm*	2	2	2	2	2	1	1
Both High and Low	3	3	3	3	3	NA	NA
Power Up	0	0	0	0	0	0	0
Test	9	9	9	9	9	9	9

* For digital input devices, a 1 indicates an alarm condition.

Table 3.9 • Interpreting Alarm Code Numbers

Setting up the Alarm Pager

Alarm Pager Reference

Each parameter has an acceptable operating range. When the parameter enters the alarm range, the parameter that is in alarm state will begin flashing on the unit. There is often a hold-off period (set by the user) that waits for the page feature to be activated. This hold-off period is to allow for a temporary out-of-bounds condition which can be caused by a power surge, etc. After the hold-off period is expired, it will activate the audible alarm (a standard feature) on the AquaNode unit. If your AquaNode has been configured and enabled for alarm pager support, an alarm page will be sent indicating the parameter is in alarm state (pH, ORP, Temperature, etc.) and the type of alarm it is (high alarm, low alarm, etc.). This digital information is then transmitted via a modem to your pager. This page consists of the last three digits of the serial number of the AquaNode unit, followed by a seven digit alarm code, as indicated in Table 3.7.

The seven digit alarm code sent by the pager indicates both which parameter (pH, ORP, temp, etc.) is in alarm condition and what that

alarm condition is (low alarm, high alarm, both high and low, power up or test). After the serial number of the unit, the first digit always refers to pH status, the second digit indicates ORP status, the third digit indicates temperature status, the fourth digit is conductivity status, the fifth is DO status and the last two digits are Input #1 and Input #2.

Table 3.8 shows the possible alarm conditions and the codes that would be displayed. Note that a “0” in any digit location indicates that no alarm condition occurred for that channel.

As an example, an alarm for an AquaNode unit with serial number 003598 was activated, indicating a high pH and low ORP condition, the page would appear as follows:

“598 2100000”

If your system has the UPS backup, this will allow you to still receive pages through the power fail detect feature of the digital input. The UPS battery provides 7-9 hours of backup. (If it used to backup a modem as well, the backup time will be shorter.) If power fails on the unit that has no backup battery, once power comes back on, the unit will dial the phone pager and send a power out message. (All zeros means the unit is powered back up after a power outage.)

After any power outage or intentional power disconnect, the page will display a “good page/bad page” message:

Programming the Software

- Good page = X
(This is how many times the page was completed.)
- Bad page = 0
(This is how many times the number was busy or the page didn't get through.)

Pager Phone Number

The first step in programming the AquaNode for pager support is the entry of the phone number you want the controller to dial in the event of an alarm condition. The pager phone number menu is accessed by pressing Enter at the pager menu prompt, under the Setup Menu. Use the directional keys to scroll through the options until you reach the pager phone number menu, and press Enter (see Appendix A-13).

Use the directional keys to select the desired numbers you wish to dial (16 characters can be entered). The number will be flashing until you press Enter to register your selection. (Note: If you enter a wrong digit, you must start the process over.) Depending on your specific situation you may need to use the dial modifiers (listed below). These are special parameters that are used to tell the modem what, when and how to dial the telephone number.

<u>Dial Modifier</u>	<u>Description</u>
0-9	Digits/characters for dialing.
,	Delay for approx. 1 sec.
W	Wait for dial tone.

The 'W' dial modifier is particularly important to make sure that there is a "dial tone" before initiating a page.

Pager Phone Number Example

The following is an example of one scenario where the pager number requires a bit more than the nine-digit phone number:

To reach the pager, it is necessary to:

- Dial 9 for an outside line.
- Wait for the dial tone.
- Dial the paging company.
- Wait a couple of seconds for the paging company to answer the phone and accept a pager input.

The pager number to be used in this example would be:

9W6195551212

(Then set 5 seconds on the Pager Delay menu for the pager to delay before sending.)



After an alarm page has been acknowledged by pressing Enter on the face of the AquaNode, if the alarm condition still exists (e.g., temperature or some other parameter is still outside the acceptable operating range.) the alarm page will be triggered again and the Retransmit Alarm function will be activated.

Pager Delay (Setup)

Every pager service company processes pager calls differently. It is therefore important that the AquaNode does not start sending information before the pager company computer is ready to receive it. For this reason, the pager delay function is a critical setting for the pager software to work properly.

The pager delay time is the amount of time that the AquaNode controller waits after it has dialed the phone number before sending the serial number and alarm values to the pager service company. The time is set in seconds. You will have to experiment with the time value to select the correct time. For example, if your pager service has a message that precedes the transmission of a page you will need to count the number of seconds or use a watch to time the message period and program this time period into the Pager Delay. If the interval is set for too short a period, the serial number and alarm code will not be properly processed by the paging system. If the time period is set for too long a period, then the pager service company may terminate the call before the alarm code information is sent. A good starting value is 5-10 seconds.

Pager Retry (Redial)

The pager retry timer is activated if the AquaNode controller is unable to send a page due to a busy phone line. The controller will wait the number of minutes specified by this command and attempt to send another page.

The default value for this command register is 5 minutes. Valid times are from 0 to 120 minutes. (Note: If you have your retry option set to "0", and the modem gets a busy signal, the alarm page would not be transmitted.)

Pager Retransmit (Until Reset)

When an alarm condition is detected, (and after the hold-off period has expired), the paging system will send a pager alarm. The AquaNode is programmed to continue the paging process until someone physically pushes the Enter key on the front of the AquaNode controller to acknowledge the page.

The pager retransmit value controls the length of time that the controller waits after the first page before it initiates another page (every 30 minutes is the default setting) — assuming that the alarm has not been acknowledged.

Pager Tone/Pulse

The pager tone/pulse command register controls whether the modem uses DTMF tones or pulses to dial the telephone. If you have a rotary phone, you will want to set the register to pulse; otherwise, leave the register at the default setting which is tone.



There could be problems in modem operation or pager functionality if the modem telephone line is shared. Be sure to use a dedicated line for the modem.

Programming the Software

Baud Rate

The pager baud rate is the actual speed in which the AquaNode can transmit data to the modem. The AquaNode baud rate can vary at rates from 300 baud to 19,200 baud. The default value is 19,200 baud, which is ideal and recommended. This value will work with 90% of the modems in use today including the Aquadyne modem that comes with the pager option. If you also have the AquaWeb option you must set the baud rate of the pager to 19,200 to match the fixed baud rate of AquaWeb.

Data Format

The pager data format register controls how information is sent to the modem. The controller defaults 8 data bits, 1 stop bit, and no parity (81N). Additional information on serial data formats is outside the scope of this manual.

If using both a pager and AquaWeb, you must use the same data format for both.

Page Now (Test Pager)

The AquaNode allows you to test the paging system at any time to insure proper operation. At the Page Now prompt in the Pager menu press Enter. When you initialize the test page, the controller will show on the LCD display that it is in the process of communicating with the modem. The page now command generates a code which consists of a "999" following the unit's serial number. Allow at least five minutes after the controller has initiated a page, to be received by your pager.



CAUTION

AquaWeb works on any properly-configured Windows 9x/NT/2000 system where dial-up networking (such as Microsoft Network) is working for other applications. Before you set up AquaWeb, verify that the dial-up networking is operational. If it is operational you would be able to dial up America Online (AOL), CompuServe, or other internet service provider.

Even after the system has been operational for some while, if you experience problems with AquaWeb, go back to the Windows environment and confirm that the dial-up networking is operational before trying to resolve an apparent problem with AquaWeb.

Contact the vendor of your networking software to troubleshoot your unsuccessful Internet connection. For example, if you use the Windows Networking software, first visit www.microsoft.com/support for late-breaking updates and technical information.

Or, on the Windows taskbar, click the Start button, click Help, click Troubleshooting, and then double-click a topic such as "If you have trouble using Dial-Up Networking."

Another resource is the Readme file on your Windows CD-ROM and/or your printed Windows documentation. Lastly, US and Canadian customers can contact Microsoft Technical Support, and all other customers can contact Microsoft Product Support Services at the Microsoft subsidiary office that serves their area.

Pager Enable/Disable

The pager enable/disable command allows you to enable or disable the paging system. If the system is disabled, no pages will be sent by the controller should an alarm condition occur.

Setting up AquaWeb

It is quick and easy to set up AquaWeb on your PC. We take advantage of Microsoft's newest setup utility for Windows 95-compliant products, such as AquaWeb. This means our setup software conforms to your PC's Windows software!

Downloading the AquaWeb Software from the Internet

1. Start Microsoft Internet Explorer, Netscape Navigator, or another Internet browser.
2. In the browser's URL text box, type ftp://www.aquadyne.com
3. On Aquadyne's FTP page, click AquaWeb.EXE.
4. When asked whether you want to open AquaWeb.EXE or save it to disk, choose Save it to disk.
5. In the Windows Save As dialog box, select C:\Program Files, leave the file name as AquaWeb in the Name text box, and then click Save.

Setting up AquaWeb on your PC

During setup, you must choose whether AquaWeb will poll your Aquadyne node(s) via a Direct Wire connection, or remotely via modem connection.

If you choose a PnP Modem connection, AquaWeb utilizes Microsoft's advanced Dial-Up Networking system.

Whichever connection you choose, AquaWeb takes advantage of Microsoft's newest setup utility for Windows compliant products. This means all your Aquadyne software conforms to Windows 9x/NT/2000 standards, in all respects!

1. Quit all other programs that may be open.
2. Verify that your PC is successfully connected to the Internet or an ISP. If you cannot verify a successful connection, do not set up AquaWeb!
3. Quit all other programs that may be open.
4. In the My Computer window, click the Start button, point to Settings, and then click Control Panel.
5. In the Control Panel window, click Add/Remove Programs.
6. On the Install/Uninstall tab of the Add/Remove Programs Properties dialog box, click Install.
7. To install AquaWeb from a Floppy disk or CD-ROM
 - a. In the Install Program from Floppy Disk or CD-ROM dialog box, click Next.
 - b. In the Run Installation Program dialog box, click Browse.
 - c. After a message says, "Please wait while Windows looks for the installation program," the Browse dialog box will display.
 - d. In the Browse dialog box, select

Programming the Software

C:\Program Files\AquaWeb, and then click Open.



Figure 3.10 • Communications Properties

e. Again in the Run Installation Program dialog box, click Finish.



Figure 3.11 • Advanced Ports Settings

8. In the WinZip Self-Extractor [AquaWeb.EXE] dialog box, click Setup.
9. The WinZip program will "unzip" a series of component files. Then a Setup message box will report further status.
10. In the 1st AquaWeb Setup dialog box, click OK.
11. In the 2nd AquaWeb Setup dialog box, do one of the following:
Click the large button to set up AquaWeb in a new AquaWeb folder.
Click Change Directory to select another folder in which to set up AquaWeb. When done in the Change Directory dialog box, click OK. Again in the 2nd AquaWeb Setup dialog box, click OK.
12. When an AquaWeb Setup dialog box says, "AquaWeb Setup was completed successfully," click OK.

Configuring the Communications System under Windows to support AquaWeb

In order to insure the proper operation of AquaWeb the communications system in Windows needs to be adjusted to insure proper operation.

1. Go to the Start Menu and select Settings and then select the Control Panel. Select the Modem Control Icon if you are using a modem in a remote data application or if you are connecting up directly to a comm port on your PC go to the Systems Icon. Select the Properties tab for either the modem or comm port that you are using. (See Figure 3.11)

2. Select the port settings button show in Figure 3.10. Figure 3.11 will appear on the screen. Make sure that the Use FIFO buffers is checked in the upper left hand corner and move both sliders to the far left position as shown in Figure 3.11.
3. Click Ok to change the communications settings and exit out of the communications control and proceed with the starting of AquaWeb.

How to Start the AquaWeb Software

1. On the Windows taskbar, click the Start button, point to Programs, and then click AquaWeb.
2. In the Welcome dialog box, do one of the following:
 - Click OK.
 - Click Purchase to register for new use of AquaWeb. When done in the Purchase dialog box, click OK. Again in the Welcome dialog box, click OK.
3. In the AquaWebLogin dialog box, type your name and password, and then click OK or press enter. AquaWeb is ready when you see a sample Network Map displayed as a "tree" list. Note: The default name and password the first time AquaWeb is run is:

Name: Administrator
Password: Octopi

How to Configure AquaWeb for a Direct Wire Connection

1. With AquaWeb running select the generatl default preferences option. This is located in the Properties section of the file menu.

2. With the General Preferences dialog box open. Select the communications port that the AquaNode is connected to. Make sure that no other program has captured the port that the AquaNode is connected to or AquaWeb will not be able to gain access to the port.

How to Configure AquaWeb for Dial-up Networking

1. Verify that your modem is a Microsoft-listed PnP modem. Non-PnP modems are not supported by Aquadyne.
2. With AquaWeb running select the generatl default preferences option. This is located in the Properties section of the file menu.
2. With the General Preferences dialog box open. Select the communications port that the modem is installed on. Make sure that no other program is currently using the port such as a fax software package.

Software Upgrades

To upgrade your H₂O/S software you will need to download the Aquadyne Downloader and keep this resident on the hard drive of your computer. The Aquadyne Downloader is available on Aquadyne's web site:

<http://www.aquadyne.com>

There are three versions of AquaWeb available:

- Standard Edition, AquaWebSE
- * Database Edition, AquaWebDB
- Network Edition, AquaWebNE

The **standard edition**, AquaWebSE, is available from our web site at no charge. It is available to all our customers and to anyone who wants to test the product. AquaWebSE allows you to view and graph data that resides in the database of any Aquadyne product with H₂O/S software.

The **database edition**, AquaWebDE, additionally supports a local database on your PC> The database retains probe data for months—or years if you wish. The software includes powerful data and graph manipulation features such as simple line and bar graphs, or more sophisticated best curve line and points and spline graphs.

The **network edition**, AquaWebNE, adds the ability to create a wide-area network (WAN) of a few or a few thousand monitoring and control nodes. Using a modem, an integrated scheduler “polls” each unit and downloads the internal datalog automatically. This means that graph data is always current—even for AquaNode units that are in a foreign country.

STEP 22—ENABLE THE AQUANODE SYSTEM CONTROL

With the installation of the hardware components complete (Steps 1-8) and the configuration of the software complete (Steps 9-23),

each system that the AquaNode controller will manage now needs to be Enabled to activate AquaNode control systems. The "System Control" menu (under the Operations Menu) allows you to set each system to either the "OFF" or "AUTO" position. In the "Off" position, the system will remain off all the time. If the system is set to the "AUTO" mode, then that system will be controlled by the AquaNode. The System Control Menu is accessed under the Operation Menu.

STEP 23—TEST THE SYSTEM CONFIGURATION.

The System Test Menu is located in the Setup Menu. Its purpose is to allow you to exercise the individual systems independent of parameter setpoints to insure that the equipment is operating properly. Upon entering the System Test Menu all systems that the AquaNode is configured to control will be shut down. By selecting the desired parameter control device (i.e. heater, chiller, or chemical dosing system, etc.), to be tested each system can be turned on or off. Upon exiting the System Test Menu all systems will be returned to their proper state.

Chapter

4

Operation & Maintenance

Operation & Maintenance

The AquaNode is designed to run 24 hours a day, 365 days a year. The only time it is not running is during maintenance.

Under normal operation the system requires virtually no interaction with the user. However, here are some hints for keeping your AquaNode in perfect operating condition:

- Check the AquaNode daily, and respond to any alarms.
- Keep it clean and a safe distance away from, heat, water, and humidity.
- Clean the probes every 90 days, or as needed.
- Recalibrate probes every 90 days, or as needed.
- Replace probes every 12-18 months, or as needed.

In the rest of this chapter, we will discuss topics that relate to the operation and maintenance of the AquaNode. The topics covered include:

1. Daily Check List
2. Cleaning the Probes
3. Calibrating the Probes
4. Replacing a Probe
5. Conducting a System Test
6. Changing a Satellite Address
7. AquaWeb Reporting and Graphing
8. Operating the Infrared Printer



Note

Probes are delicate instruments that can be damaged by improper handling, installation or poor maintenance. Damaged probes will cause inaccurate parameter measurements and operational problems for systems configured for control.

Please review Chapter 5 “Probe Problems” for troubleshooting tips.

1. DAILY CHECK LIST

By checking your AquaNode controller daily, you can identify a potential problem early.

1. Check your conductivity, temperature, pH, DO, and ORP values and compare them to the optimal levels for your environment.
2. Check all of your peripheral devices to ensure proper operation (i.e. heater, chiller, ozonizer, pH doser).
3. Check the System Status light for solid green. If the light is not solid green, refer to the Quick Reference Card.
4. Look for signs of stress on all aquatic inhabitants, if any.
5. Respond to any AquaNode alarms.

Should an alarm condition occur, pressing Enter key will reset the alarm - terminating further audible and pager alarms for that event. However, as long as the parameter value stays within the alarm range, an alarm message will be

displayed in the status line. Once the parameter value returns to acceptable Operating Range, the alarm will be turned off and the status message will be removed.

2. CLEANING THE PROBES

For maximum accuracy, it is important to keep the probes clean. Probes require cleaning because a residue will collect on the probe after a period of time. This residue comes from the chemicals and algae that flow through your system. It is recommended that you clean your probes at least every 90 days. However, more frequent calibrations provide greater accuracy—especially in harsh aquatic environments. This simple process will help prolong the life of your probes. A screen prompt on the AquaNode LCD will display every 90 days to remind you to do so.



To Reset the clean probes message go to Operation/Clean Probes/Reset “Clean Probes” Timer.

Cleaning the Conductivity Probe

The conductivity probe can develop deposits over the graphite sensors which will interfere with accurate conductivity readings. Since such deposits are often colorless, they may go unnoticed. To keep the probes clean, use Lime-Away or other household descaler... Rinse the probe completely before returning it to your system. The frequency

required for this cleaning depends on the water quality. For relatively clean fresh water, this cleaning might be required only once per year. For highly saline water, it might be advisable to clean once per week.

Cleaning the Temperature Probe

Begin by removing the probe from the mount. The temperature probe only requires a good wiping from a soft dry towel to clean it.

Cleaning pH and ORP Probes

The pH and ORP probes require a little more work. Remove the probe from its mount and wipe with a clean towel. Begin by soaking the probes for 5 minutes in lemon juice. Then take a Q-tip and dip it into some lemon juice and clean the probe tip, as shown in Figure 4.1. The citric acid from the lemon juice helps to remove any chemically hardened residue that would impede the probe from making an accurate reading. Aquadyne does

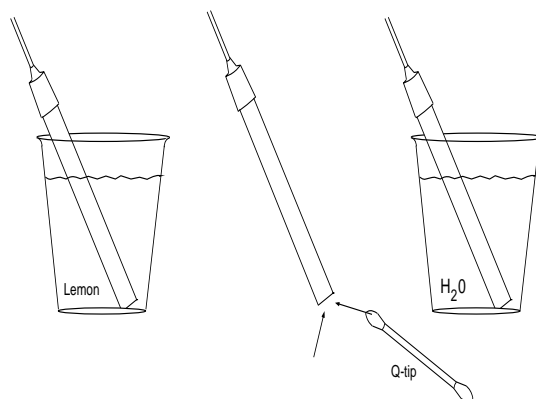

Figure 4.1 Cleaning the pH & ORP Probes

Operation & Maintenance

not recommend the use of any hazardous chemicals when cleaning probes, unless the process is supervised by qualified personnel. Do not use abrasive cleansers or sponges to clean probes since this can scratch and damage the probe.

Cleaning YSI DO Probe, Membrane Maintenance, and Probe Service.

Membrane Cap Installation

WARNING: Use only YSI MEA probe solution in the membrane cap. Any other solution will damage the MEA sensor.

To install a new membrane cap on your YSI DO probe:

1. Unscrew and remove the probe sensor guard.
2. Unscrew and remove the old membrane cap.
3. Thoroughly rinse the sensor tip with distilled water.
4. Hold the membrane cap and add 8 to 9 drops of MEA probe solution (about half full).
5. Tap the bottom of the cap with your finger a few times to remove any trapped air bubbles. **DON'T TOUCH THE MEMBRANE SURFACE!**
6. Screw the membrane cap onto the probe tightly by hand (to prevent leakage of electrolyte.) A small amount of probe solution should overflow.

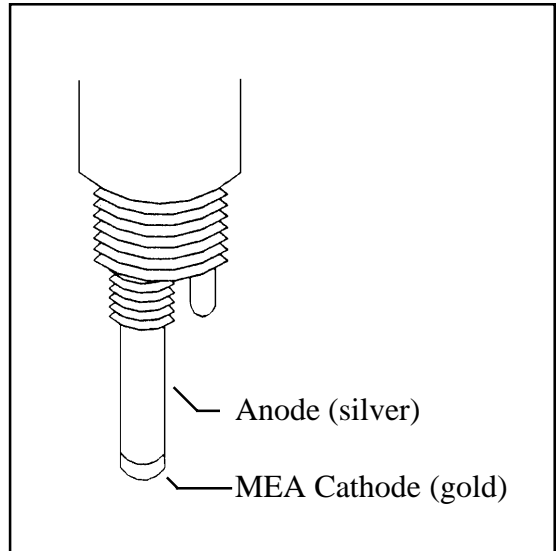

Figure 4.2 YSI DO Probe

6. Shake off any excess probe solution and rinse the stainless steel thoroughly with distilled water to prevent corrosion.

Anode Service

The MEA oxygen sensor is, in principle, the same as the conventional Clark oxygen sensor in that the sensor is made of a silver anode and gold cathode, but the cathode is a micro-electrode array. Since the current of the MEA



WARNING: Under no circumstances should ammonium hydroxide be used to clean the silver anode. Ammonium hydroxide will permanently damage the condition of the MEA surface.

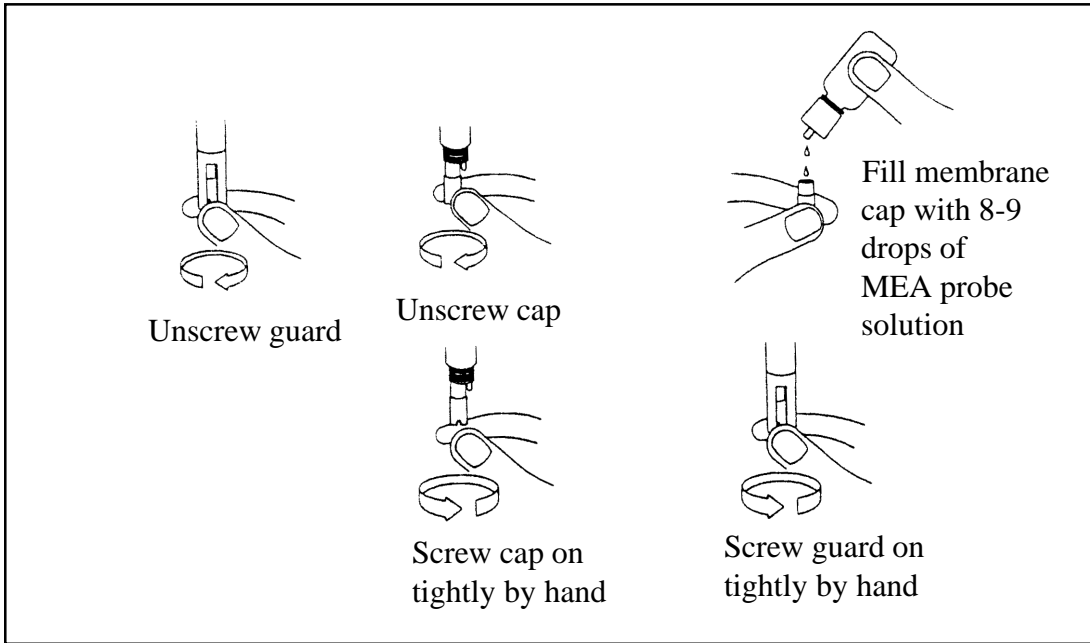

Figure 4.3 YSI DO Probe Membrane Replacement

oxygen sensor is so much smaller (on average 100 times smaller) than the current of YSI conventional oxygen sensors, consumption of the silver anode due to formation of AGCl, is minimal during the lifetime of the probe. There should not be any significant build-up of silver chloride at the surface of the anode for 3 to 4 years, therefore the anode should not require chemical cleaning. However, if the surface of the silver anode has become fouled, gently wet sand it using 400 grit wet/dry sandpaper, rinse thoroughly with deionized or distilled water and wipe with a wet paper towel.

Cathode Service

If the MEA oxygen sensor exhibits erratic behavior, such as a current rise of a rate of 1%/hour or very jumpy readings, then it can be serviced by buffing (a few light twists against the surface) with the wet micro-cloth mounted on the buffing tool provided in the YSI 9503 reconditioning kit.



WARNING: Under no circumstances should the gold cathode surface (the MES surface) be sanded. Sanding will permanently damage the condition of the MEA surface.

Operation & Maintenance

YSI DO Probe Precautions.

The YSI DO probe service depends on the environment that the probe is located in. If the probe is properly maintained, one membrane cap should last two to four weeks. It is recommended that membrane caps not be re-used.

To keep the electrolyte from drying out, when the probe is not in use, store the probe in a moist environment, such as the plastic bottle the probe came in. Make sure the sponge is kept wet in the bottle.

Erratic reading are a result of loose, wrinkled, damaged, or fouled membranes, or from large (more than 1/4 of the circumference of the probe) bubbles in the electrolyte reservoir. If erratic readings or evidence of membrane damage occurs, you should replace the membrane cap and the KCl solution. The average replacement interval is two to four weeks.

If the membrane is coated with oxygen consuming (e.g. bacteria) or oxygen evolving organisms (e.g. algae), erroneous readings may occur.

Chlorine, sulfur dioxide, nitric oxide, and nitrous oxide can affect readings by behaving like oxygen at the probe. If you suspect erroneous readings, it may be necessary to determine if these gases are the cause.

Avoid any environment which contains substances that may attack the probe materials. Some of these substances are concentrated acids, caustics, and strong solvents. The probe materials that come in contact with the sample include FEP Teflon, stainless steel, epoxy, polyetherimide and the polyurethane cable covering.

Do not allow the probe to strike hard objects. The membrane or sensor inside may be damaged.

Cleaning OxyGuard DO Probe, Membrane Replacement, and Probe Renovation.

Cleaning OxyGuard DO Probe

The probe's membrane must be kept free from deposits. All surfaces in a biologically active system will be covered by a film which acts as a barrier to the oxygen that must diffuse through the membrane. The membrane must, therefore, be cleaned at regular intervals, the frequency depending on the actual conditions. Cleaning can be performed with a cloth or soft paper towel. The membrane is strong and not easily damaged, but care must be taken when cleaning.

Membrane Replacement

A new membrane can easily be fitted to the membrane cap as follows:

1. Unscrew the retaining ring using a coin or membrane tool (if purchased).
2. Remove the old membrane and O-ring. Rinse with water and wipe dry.
3. Install new O-ring and membrane.

The O-ring must be installed first with the membrane placed on top it.

4. Screw in the retaining ring and tighten firmly. After installation the membrane must be flat - if it wrinkles remove it and try again until the membrane is taught and flat.

Operation & Maintenance

Turning the membrane over often helps. If not replace with a new one.

Spare membranes are supplied in a plastic bag layered between paper discs. Do not install the paper discs.

A membrane can only be used once.

A membrane cap should not be re-used without replacing the membrane and O-ring. When a membrane cap is screwed onto the probe, the membrane is stretched by the cathode. If the same cap and membrane is used a second time it will not fit perfectly



Note

The OxyGuard probe should NOT be taken apart unless it needs renovation!

There is no need to exchange the electrolyte on a regular basis. Renovation becomes necessary when the probe behaves erratically and/or it is no longer possible to obtain a correct calibration value. Refer to Troubleshooting (Section 5)

onto the cathode and will result in erratic readings, and will not fit perfectly a second time.

Probe Renovation

To renovate the OxyGuard DO probe:

1. Rinse the probe in water and wipe clean.

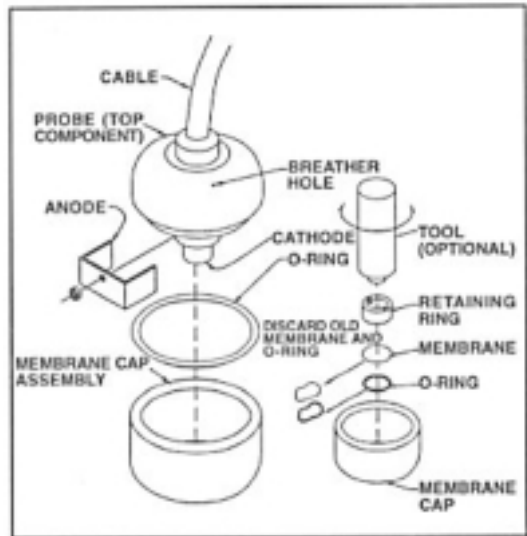

Figure 4.4 OxyGuard DO Probe

Exploded View

2. Unscrew the cap and rinse the probe internals with water.
3. Inspect the anode. Clean off any loose white deposits with a non-metallic brush, e.g. a hard toothbrush. Do not scrape the anode with any metallic object. If the anode is very corroded replace it. Anodes usually last approximately 4 years. Check that the nut under the anode is tight before fitting a new anode.
4. Inspect the cathode and remove any deposits using wet or dry emery paper, 400 grit.

The cathode must not be polished

5. Check that the small vent hole in the top of the probe is open. If

Operation & Maintenance

necessary, it can be cleaned with a needle.

6. Replace the large O-ring with a new one if it is damaged.
7. Fill a new (or renovated) membrane cap to the brim with electrolyte, and fit it to the upper part by holding the upper part with the vent hole away from you. Engage the cap with the upper part and slowly screw the cap into place without turning backwards at any time. Ensure that the large O-ring seats properly. Excess electrolyte should dribble out of the vent hole.

8. Tighten the cap firmly by hand.

After renovation the probe can be regarded as new. It should be hung up in air to stabilize for at least an hour before calibration. If possible re-calibrate after a day or two.

3. CALIBRATING THE PROBES

Probes require periodic calibration to maintain accuracy. Each probe is calibrated through a simple process of placing it into a standard solution of known water quality. The pH and ORP probe reading are corrected in software for temperature compensation. It is

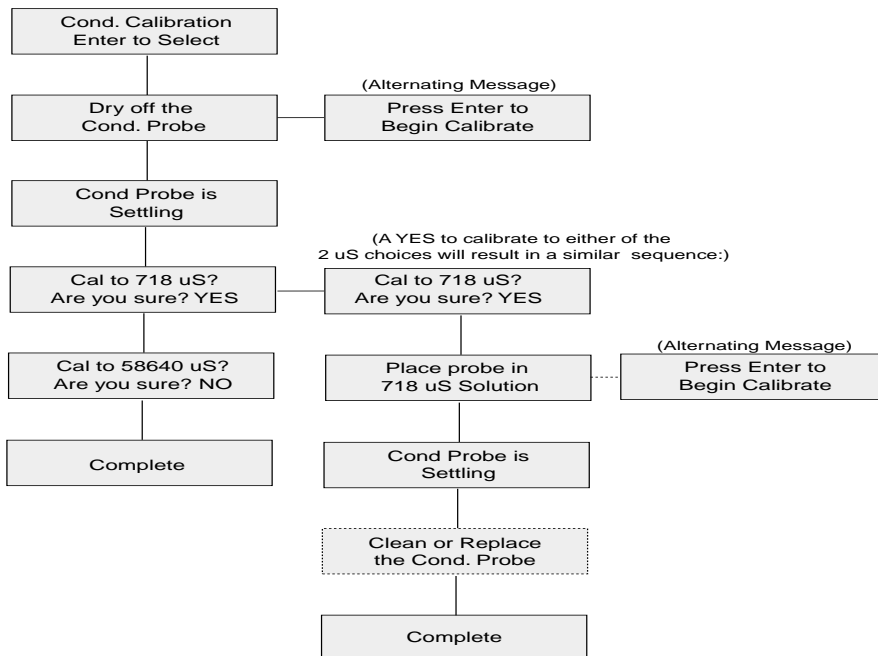

Figure 4.5 Conductivity Probe Calibration

for this reason that the temperature probe must always be included in the calibration solutions when either the pH or ORP probes are calibrated. However, the conductivity probe does not require the use of the Temperature probe to complete the calibration process.

Calibrating the Conductivity Probe

The Conductivity probe calibration is a two-part process:

- Step 1—Calibrate to zero.
This is done by calibrating a dry probe out of water.
- Step 2—Calibrate to one of two standard solutions.
This is done by placing the probe in a solution of known conductivity (718 uS, or 58,640 uS).

From the Operations Menu, use the arrows to scroll to the Probe Calibrate Menu. After you respond to the “Are You Sure?” prompt, use the arrow keys to scroll to the Conductivity Calibration menu, and press Enter. During the calibration process you will see the following menu prompts shown in Figure 4.5.

You are directed to dry off the probe then push Enter and begin the dry calibration. When the probe is calibrating the Display Window will read “Cond Probe is Settling.”

At this point you will be prompted to enter the calibration solution. Then place the probe in

the solution for calibration. Repeat the calibration procedures for the four standard solutions.

If the probe calibrates properly, the screen will return to the Operation Menu. If the AquaNode cannot calibrate a probe to within 15% of its design specification, a message will be displayed, “Clean or Replace Probe.”

Calibrating the Temperature Probe

Aquadyne offers a temperature probe that is calibrated and accurate up to ± 0.4 degrees. It is guaranteed to be accurate to within ± 1 degree at 77° F. Should you wish to recalibrate the temperature probe, do so as follows:

1. From the Top Level Display, press Enter and then press the right arrow and go to the Operation Menu. Press Enter.
2. Next, press the right arrow once to get to the Probe Calibrate menu. Press Enter.
3. Then press the right arrow three times to see the display Temp Calibration. Press Enter to Select.

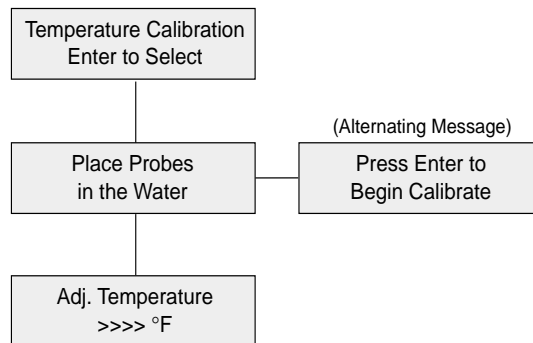

Figure 4.6 Temperature Probe Calibration

Operation & Maintenance



Note

To insure accurate reading it is critical that the unit be calibrated with a conductivity buffer consistent with the range that the conductivity system will be operated in. Aquadyne recommends calibrating the low range with a 718 uS buffer and the high range with a 58,640 uS buffer. Failure to do this will yield inconsistent readings.

4. Measure the temperature of a water sample with an accurate thermometer.
5. Read the temperature.
6. Place the probe in the sample and adjust the temperature using left and right arrows until the screen value matches the thermometer reading.
7. Press Enter twice to return to the Top Level Display.

The menus that appear on the AquaNode display during calibration are shown in Figure 4.6.

Calibrating the pH Probe

The pH probe requires a few more steps to calibrate. The pH calibration is done using two different buffer solutions. Standard buffer solution choices are pH 4, 5, 6, 7, 8, 9, and 10. Calibrate the probe using two buffer solutions. It is best to choose buffers which surround the application range (i.e. saltwater use pH 7 & 10, fresh water use pH 4 and 7) Set up three cups: Buffer Solution #1 in the

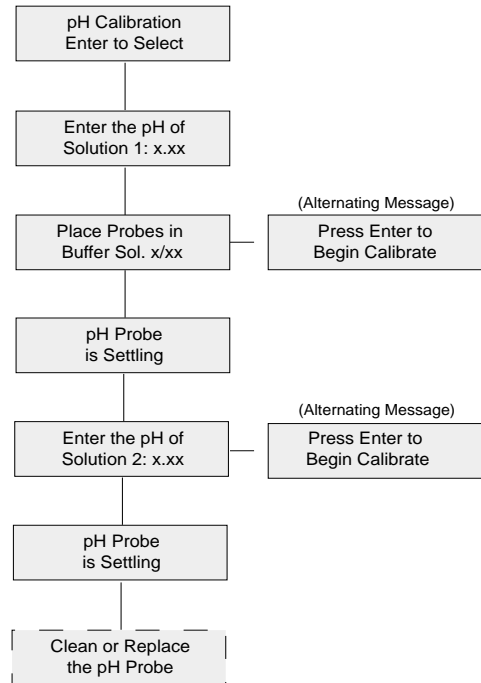

Figure 4.7 pH Calibration Menu

first cup, Buffer Solution #2 in the second cup, and distilled water in the third cup, as shown in Figure 4.8.



Note

It is important that the buffer solution in cup #1 is the HIGHER of the two buffers being used. For example, if you are using buffers 7 & 10, cup #1 should contain pH 10 buffer.

Operation & Maintenance

During calibration the AquaNode controller will prompt you, asking you which solution you wish to use for Buffer Solution #1, and Buffer Solution #2. Simply follow the prompts on the display screen. The menu prompts should be as shown in Figure 4.7.

When preparing a new probe for first use, carefully remove the probe from the soaker bottle. Be sure to save the bottle in case the



Figure 4.8 pH Calibration Solution

probe needs to be stored at some later date. Rinse the probe in the distilled water and shake it off.

Next, place the pH probe and the temperature probe into the Buffer Solution #1. The AquaNode controller will let you know when the readings are stable, so you can remove the probes, rinse them thoroughly in the tank water cup, and proceed to the next step.

Finally, place the pH probe and the temperature probe into Buffer Solution #2. Wait at least 2 minute (or up to 5 minutes if the probes are not new), before pressing the Enter key to begin calibration of the probes. The controller should indicate the probe is now calibrated. After cleaning the probes in the

tank water cup and drying excess water off the probes, they are ready to be put back into the system. If the probes are not within the tolerance limits, the message will read, "Clean or Replace Probe." Should this occur, clean the probe, and try to recalibrate it.

If you have cleaned the probe twice and you are still having problems, you will need to purchase an Aquadyne replacement probe from the dealer where you purchased the AquaNode.

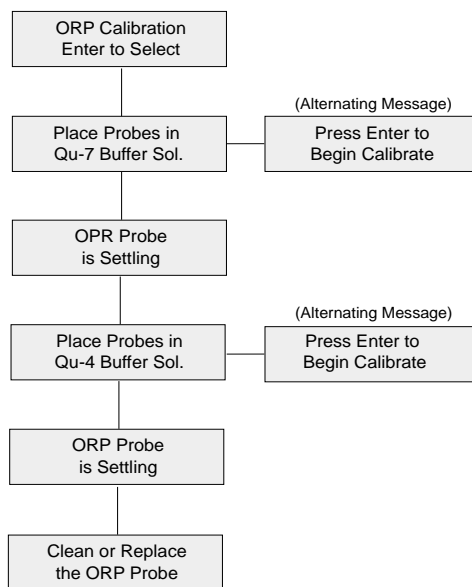

Figure 4.9 ORP Calibration Menu

Calibrating the ORP Probe

Calibration of the ORP probe follows the same general steps as for the pH probe

Operation & Maintenance

except for two differences:

- When setting up your cups for ORP calibration, you will need to add Quinhydrone to each of the Buffer Solutions.
- You must use **only pH-4 and pH-7 Buffer Solutions** with Quinhydrone.

Proceed with the calibration procedure, as follows:

1. Dip the stir stick provided into the Quinhydrone powder and remove a heaping portion on the bottom 1/4-inch of the stick.
2. Mix this powder into one of the buffer solutions (pH-4 or pH-7). Some of the Quinhydrone should remain undissolved. If the Quinhydrone dissolves completely, add more.
3. Use a different stir stick and repeat this procedure for the second buffer solution.
4. At the AquaNode controller, press the Enter key from any place on the Top Level Display, you will be at the Setpoint Menu. Use the arrow keys to scroll to the Operation Menu and press the Enter key. Use the arrow keys to scroll to the Probe Calibrate sub-menu. When you press the Enter key, you will be prompted whether you wish to continue with probe calibration. After selecting yes, the menus will prompt you through the calibration process, as shown in Figure 4.9. Be sure to let the probes settle in the calibration solution at least one minute before pressing Enter to begin calibration.

Calibrating the YSI and OxyGuard DO Probes

Frequency of calibration depends upon accuracy desired. A newly service probe needs more frequent calibration than an “old” one. If an accuracy of +/- 0.5 ppm is sufficient, calibration once a month is more than enough. It is, however, much better to perform one thorough calibration than two quick ones.

Accuracy of calibration depends primarily on the probe having reached equilibrium with the temperature at which you are calibrating.

Dissolved oxygen calibration must be done in an environment with a known oxygen content. Since the amount of oxygen in the atmosphere is known, it makes an excellent environment for calibration (at 100% relative humidity.) The calibration/storage container the DO probe ships in contains a moist sponge to create a 100 % water saturated air environment.

To accurately calibrate the DO probe you will need to know the following information:

- The approximate altitude of the region in which you are located
- The approximate salinity of the samples that you will be measuring. Fresh water has a salinity of approximately zero. Sea water has a salinity of approximately 35 ppt (parts per thousand).

The AquaNode can be calibrated using either 100% Saturated Air as a standard or a known DO level in solution. Calibration Mode 1 uses

Operation & Maintenance

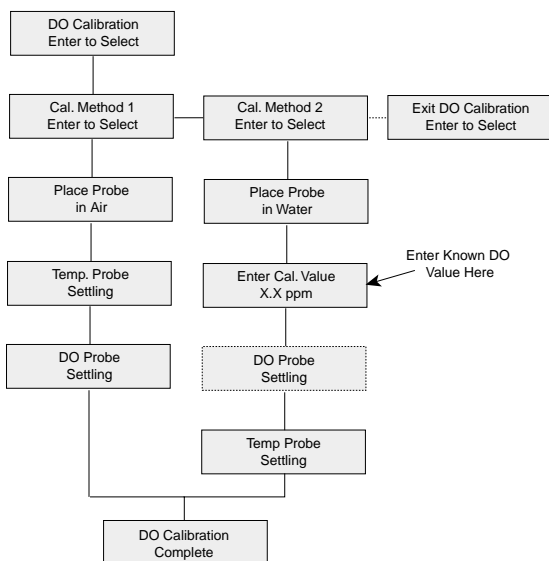

Figure 4.10 DO Calibration Menu

100 % saturated air for the YSI probe, and room air for the OxyGuard probe, and Calibration Mode 2 uses a known DO standard for both YSI and OxyGuard probes. Each calibration procedure is described below.

Calibration Method 1 (YSI Probe)

1. Place the DO probe in its shipping container and locate the temperature next to it. Allow 10 minutes for the temperature probe and DO probe to equalize to the same temperature.
2. In the Setup Menu under Dissolved Oxygen menu go to the Elevation menu and enter the current elevation that you are at in increments of 500 ft.
3. In the same menu enter the Salinity in



Note

You MUST use the calibration adapter to calibrate the OxyGuard probe using method 1. The probe will fail calibration without it.

ppt of the water which will be sampled.

4. Go to the operations menu and select the Dissolved Oxygen calibration and select 'Calibration Method 1'. Press enter and the AquaNode will calibrate the DO probe automatically.

Calibration Method 1 (OxyGuard Probe)

1. Unplug the OxyGuard DO probe from the AquaNode and plug the calibration adapter into the DO socket on the AquaNode. Plug the OxyGuard probe into the calibration adapter. Take the probe out of the water, wipe the membrane dry, and hang it in the air away from direct sunlight. Allow 10 minutes for the DO probe to reach temperature equilibrium.
2. In the Setup Menu under Dissolved Oxygen menu go to the Elevation menu and enter the current elevation that you are at in increments of 500 ft.
3. In the same menu enter the Salinity in ppt of the water which will be sampled.
4. Go to the operations menu and select the Dissolved Oxygen calibration and select 'Calibration Method 1'. Press enter and the AquaNode will calibrate the DO probe automatically.

Operation & Maintenance

Calibration Method 2 (YSI or OxyGuard Probe)

1. Place the DO probe and temperature probe in a solution of a known DO level. Allow 10 minutes for the temperature probe and DO probe to equalize to the same temperature.
2. In the Setup Menu under Dissolved Oxygen menu go to the Elevation menu and enter the current elevation that you are at in increments of 500 ft.
3. In the same menu enter the Salinity in ppt of the water which will be sampled.
4. Go to the Calibration menu in the Operations Menu and select DO calibration. Select Method 2 and Enter the known DO level taken from another reference source.
5. The AquaNode's DO system will now be adjusted to match the reference system.

4. REPLACING A PROBE

Replace your pH and ORP probes every 18 months for Aquadyne laboratory grade probes, 12 months for standard grade



Note

If you leave the controller in the System Test Mode unattended for 10 minutes or more, the controller will automatically revert back its state prior to entering System Test.

probes, or as needed for accuracy and reliability. Replacement probes can be purchased from the store where you purchased your AquaNode controller. For a list of dealers nearest you, check Aquadyne's Web site at <http://www.aquadyne.com> or call Aquadyne Customer Service.

5. CONDUCTING A SYSTEM TEST

When you conduct a System Test, all configured Satellite Modules and built-in relays automatically go to an "off" condition. Once in the System Test mode, you can select any Satellite Module and manually turn it on or off. The purpose of this test is to make sure each Satellite Module is working and that its address is correct. Remember, the Satellite address on the Satellite Module for the device **MUST MATCH** the Satellite address that was set in the AquaNode H₂O/S software. (Refer to the Menu Map: Look for the Set Satellite ID Menu under the Setup Menu).

When you exit System Test, each Satellite Module will revert to the ON or OFF state that it was in prior to System Test.

To conduct a System Test, first press Enter from any position on the Top Level Display, you will be at the Setpoints Menu. Use the arrow keys to scroll to the Setup Menu then press Enter.

You should now be at the System Test sub-menu. When you press Enter again, you will be at the Heater Test screen. Use the arrow keys to scroll to the system you desire to test. When you are at the desired screen, press Enter. This will default to the System Control OFF screen. Use the arrow key to scroll to the System Control ON screen and press Enter. This will test the desired system.

6. CHANGING A SATELLITE ADDRESS

To change the address of a Satellite Module, turn the top dial pointer to the number you desire and the bottom dial pointer to the ID (letter) you desire. Once you have changed the address on the Satellite module, be sure to change the corresponding address in the AquaNode controller.

7. AQUAWEB REPORTING AND GRAPHING

AquaWeb is a 32-bit Windows 9x/NT/2000 application that provides remote access and network management services between a PC and the H₂O/S software that resides in every AquaNode, Octopus and AquaGuard monitoring and control system.

The sole function of the software is to assist nontechnical users with the complex task of monitoring local- or remotely-connected AquaGuards or AquaNode units.

AquaWeb works very much like an e-mail system. Periodically, AquaWeb initiates a direct or modem-to-modem dial-up connection with a "node" (Octopus, AquaNode, or AquaGuard). Once connected, many actions can then be accomplished, including downloading of the datalog, viewing current conditions, reviewing configuration setpoints, uptime, and graphing data.

Your AquaNode monitoring system is ready to communicate with any AquaWeb-enabled Windows PC. Aquadyne's security system allows only authorized users access to your systems and your data.

For further information about AquaWeb, consult the AquaNet On-Line User Manual, or visit our WEB page at:

<http://www.aquadyne.com>

8. OPERATING THE INFRARED PRINTER

You will notice that in the bottom left hand corner of the AquaNode controller face there is an Infrared Port. This infrared transmitter

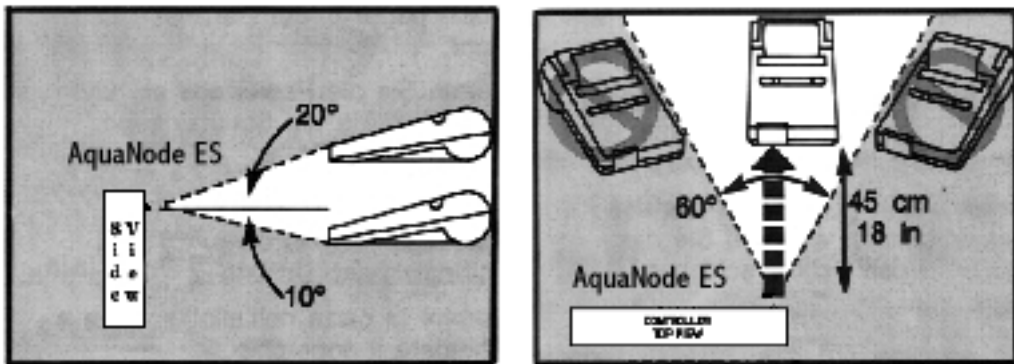

Figure 4.11 Holding the Infrared Printer

Operation & Maintenance

is similar to the remote control used to send commands to a television.

The AquaNode communicates with the HP 82240B Infrared Printer via a beam of invisible infrared light. The receiver on the printer is located in the lower left front corner of the printer.

You must hold the HP printer within 18 inches of the infrared port for the printer to be able to pick up the data and operate properly.

Figure 4.11 shows how to position the HP printer to the AquaNode for the best operation. The top illustration shows a side view of the AquaNode and printer. The printer should be held with no more than 20° above horizontal or 10° below horizontal. The bottom illustration is a top view of the AquaNode and printer. You want the printer to point basically straight ahead at the AquaNode. As shown in the illustration, there is a little flexibility from "straight ahead."

Make sure that the printer is held steady and within 18 inches of the AquaNode while data is being sent. The printer will pause during graphing. The printer must be held in place until the "Printing" message is no longer on the display.

While the AquaNode controller is sending data to the printer, it will not respond to user input. The System Status Light will flash green and yellow and the display will indicate that it is printing.

To begin using the printer, you must first install the batteries and a roll of thermal paper which comes with the printer. Refer to the User's Manual that comes with the printer for instructions on installing the

batteries and paper. If desired, you may order an optional battery eliminator to use the printer without batteries. Paper is also available in packages of six rolls.

Printer Menus

The printer commands are accessed through the Operations Menu. This menu allows you to select the information you want to print.

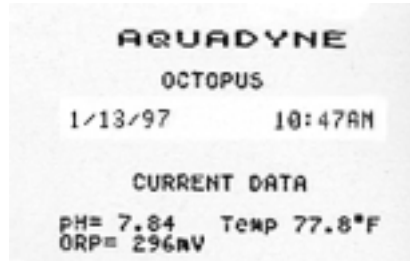

The printer menu provides you with the choice of three data formats, current, high/low, and graph.

Current Data

When you select current data, you will receive a printout showing the current readings for each of the systems that you are monitoring or controlling with the AquaNode. Your printout will look like this:

High and Low Data

If you want to know what the peak high and peak low values were, use the High/Low menu. The AquaNode monitors high and low points separately from the hourly data. The High/Low value is a peak detector that is recorded during, each hour. You may find that your peak level will be different from the hourly data. Your options are a 24 hour, 48

hour, or one week period. Based on your selections the printout will appear as shown in the chart below.

1 WEEK HIGH/LOW DATA

High pH = 8.32

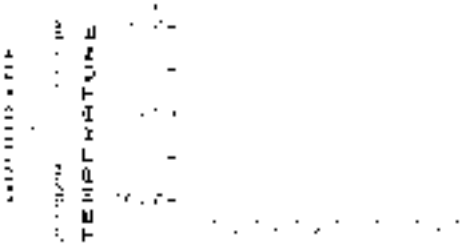

Figure 4.12 • Temperature 7-day Graph

Low pH = 7.95

High ORP = 165 mv

Low ORP = 280 mv

High Temp = 78.0°F

Low Temp = 77.5°F



Figure 4.13 • pH 48-Hour Graph

Graph Data

In the graph mode, the AquaNode plots the data that it has been collected over the week of operation. The printer will automatically scale the Y-axis to make sure that the plot will always display all of the data points.

The X-axis tick marks are labeled in hours if you are plotting in 24-hour or 48-hour mode.

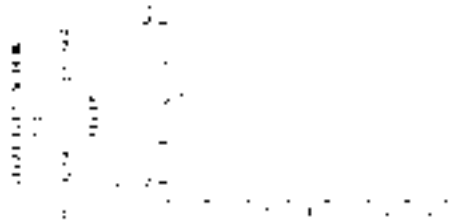

Figure 4.14 • ORP 7-day Graph

If you plot the last week's data, the tick marks represent one day of data collection. The most recent data sample is always shown on the far right hand side of the graph.

On all the plots, each mark represents the hourly collection point. The graphs shown in Figures 4.12, 4.13, and 4.14 are rough approximations of the type of charting that the AquaNode controller will perform. Graphs are labeled with its type (Temp, pH, or ORP). The date and time that the graph is printed is also on every chart. **(The AquaNode does not currently support datalogging of conductivity measurements.)**

Chapter

5

Troubleshooting

Troubleshooting

The most common troubleshooting questions are in the following three areas:

- Probe readings,
- Peripheral equipment response, and
- Modem/pager feature.

PROBE TROUBLESHOOTING

Symptom	Possible Cause	Solution
1. Probe reading fluctuates or only <<< or >>> are displayed	a. Probe cap has not been removed	Verify that all protective caps have been removed from the probes.
	b. Improper placement of probe	<p>The pH and ORP probes must be located within 6 inches of the temperature/Accu-read probe.</p> <p>Probes location must have sufficient water movement.</p> <p>Verify that probes are plugged into the proper Octopus port.</p>
	c. Induced voltage interference	<p>Place pH, ORP, and temp probes in a cup of aquarium water. If readings stabilize, the problem may be due to induced voltage interference. (If probe readings do NOT stabilize, refer to Possible Cause #4)</p> <p>Powerheads, pumps, and other aquarium equipment can leak voltage into the body of water. This can affect probe accuracy and longevity. The Octopus compensates for induced voltage of 4 volts peak to peak. Voltage exceeding this level must be removed via the addition of a solution ground placed directly next to equipment causing the leak.</p>

PROBE TROUBLESHOOTING—*Cont'd*

Symptom	Possible Cause	Solution
1. Probe reading fluctuates or only <<< or >>> are displayed	d. RF (Radio frequency) interference	<p>Turn off all equipment other than the Controller unit. If the probe readings stabilize, the problem may be a result of RF interference. (If probes DO NOT stabilize, all Aquadyne Technical Support at 858 569-2082</p> <p>High output equipment such as ozonizers, chillers, and electronic ballasts emit RF under normal operation. (RF can also be generated by household equipment such as TVs, refrigerators, dryers, etc.) The RF noise can be received by the probes or probe cables and will cause inaccurate readings to be displayed. If this is the problem attempt to relocate the probes as far away from the known source as possible. If this does not resolve the problem, the probes must be shielded using metal conduit which has been grounded. If this does not resolve the problem, contact Aquadyne for assistance.</p>
	e. Probe is dirty damaged or defective	<p>Calibrate the probe using the procedure described in Chapter 4.</p> <p>Clean probe if Octopus message reads, "Clean or Replace Probe." If this does not resolve the problem, the probe may require replacement.</p>
2. No changes in parameter probe readings (flat line reading)	a. Probe is bad	<p>Replace probe. (Be sure to eliminate possible causes before</p>

Troubleshooting

PROBE TROUBLESHOOTING—*Cont'd*

Symptom	Possible Cause	Solution
Fluctuating reading with OxyGuard DO Probe when probe is shaken or bumped lightly i.e. probe is erratic.	Probe has lost electrolyte a sloshing noise will be heard when the probe is shaken. Torn or damaged membrane Wet connections in the wiring or in the probe.	Determine whether it is a physical or electronic problem with the probe. Unscrew the membrane cap, discard the electrolyte, membrane, and membrane O-ring. Dry the internals of the electrode, especially the cathode with a soft cloth. With the system 'ON' observe the display: If the display reads zero the probe and cable circuitry are OK. Service the probe and change the membrane. If the display does not read zero, but some other value, then there is probably moisture somewhere.
With membrane cap removed and probe internals dry, the display does not read zero or reads erratic values	Moisture has entered the probe or cable. The moisture creates a secondary galvanic action in addition to that produced by the probe and results in a non-zero or erratic readings.	Locate the source of moisture by process of elimination. If moisture has entered a cable joint or junction box, thoroughly dry out the area and take measures to prevent reoccurrence. If it is suspected that moisture has entered the top half of the probe at the cable entry, contact Aquadyne. The probe can be repaired by backing off the cable gland thus exposing the internal wiring. Dry out the probe with a small jet of compressed air or over gentle heat or both. Drying out the the probe is best left to the supplier.
Probe will not calibrate in the air.	Probe has dried out-No electrolyte inside. Probe is overdue for servicing - excessive build up of anode oxide. A deposit has built up on the cathode.	Service the probe and change the membrane. Use a stiff brush to remove the loose oxide layer. If it is suspected that the anode is badly corroded, change it. If it is suspected that a deposit has developed on the silver cathode. Clean the cathode with 400 grit wet/dry sand paper, wet/dry emery paper or with some scouring powder. Be careful not to polish the cathode - the surface must remain dull. (Do not use a wire brush.

PROBE TROUBLESHOOTING—*Cont'd*

Symptom	Possible Cause	Solution
3. Abnormally low conductivity readings	a. In-line probe has been inserted too far into the flow stream portion of the tee-fitting	Reposition the probe so that the probe extends only about 10% into the flow stream. Be sure the compression fitting is secure and that the probe is supported independently from the compression fitting.

PERIPHERAL EQUIPMENT RESPONSE TROUBLESHOOTING

1. Equipment does not turn on/off at the proper time	a. Satellite ID may be assigned incorrectly	Review Chapter 2, Step 5 and Chapter 3, Step 22 to be sure the ID on the satellite module matches the ID assigned on the Octopus software.
	b. Desired control function may not be set to Auto mode.	Verify the desired control function is set to Auto control. From the Top Level Display, press Enter to get to the Main Menu (Setpoints Menu). Press the arrow to the right to go to the Operation Menu. Press Enter to get to the System Control submenu and continue to verify Auto control. Refer to Appendix A, Menu Maps. page A-6.
	c. Satellite may be plugged into a power strip with surge protection	Although it is recommended that the Octopus controller and modem be protected by a power strip with surge suppression, the X-10 Control Module and any satellites SHOULD NOT be on any power line with surge suppression. The surge suppression acts as a filter on the line and can interfere with signals that the Octopus sends the X-10 control module.

Troubleshooting

PERIPHERAL EQUIPMENT RESPONSE

TROUBLESHOOTING—*Cont'd*

Symptom	Possible Cause	Solution
1. Equipment does not turn on/off at the proper time <i>Cont'd</i>	d. Satellite and Octopus are on different phase of power source.	Plug the Octopus, the X-10 control module and all satellites into power outlets that are on the SAME PHASE of the electrical sub-panel. If you wish to place equipment on multiple phases, a signal bridge is required.
	e. Malfunction with a particular satellite or satellite address	If possible, attempt to use a different satellite and/or address to see if this resolves the problem.
	f. RF (radio frequency) interference	Refer to the RF interference discussion in the "Probe Problems" troubleshooting section above.

MODEM/PAGER TROUBLESHOOTING

1. No response from the modem	a. Modem and Octopus controller are not talking	<p>Check to insure that the cables are fully plugged into the Octopus controller and the data rates and formats are set for the modem being used. The standard data rate is 19,200 baud with 8 data bits, 1 stop bit, and no parity (81N).</p> <p>Verify that power is being supplied to the modem when the Octopus controller is sending.</p>
2. No modem dial tone	a. The modem attempted to dial the phone but when it checked for dial tone, none was present	Verify that the phone line is live and that the phone cable is plugged into the jack labeled LINE.

MODEM/PAGER TROUBLESHOOTING—*Cont'd*

Symptom	Possible Cause	Solution
3. Bad Response message	a. The Octopus controller was unable to understand the message sent back from the modem	Verify that the cables are plugged securely into the Octopus and that the data rates and formats are set for the modem being used. The standard data rate is 19,200 baud with 8 data bits, 1 stop bit, and no parity (81N).
4. Page not going through properly	a. Modem is connected to a multi-telephone system	The modem should not be connected to a multi-line telephone system (such as PBX) as this may interfere with proper communication of the modem. Connect the modem to a single telephone direct line.
	b. An extra feature (such as voice mailbox, etc.) on the paging service may be interfering with pager function	When the alarm pager is activated, it dials the number that was entered in the Octopus software. Then when it begins to transmit the page message, it first sends the serial number of the Octopus that is alarming. Depending on any extra features (such as voice mail) provided by your paging service, the first digit in the serial number may activate that extra service (such as voice mail), the alarm page is forwarded to the voice mail, and the page is never sent. Verify with your pager service that there are no extra service features that could interfere with the alarm page.
	c. Paging feature not enabled on the Octopus software	Enable the paging function on the Setup Menu.

Troubleshooting

NOTES:

NOTES:

Appendix

A

Menu Maps

Menu Maps

MAIN MENU

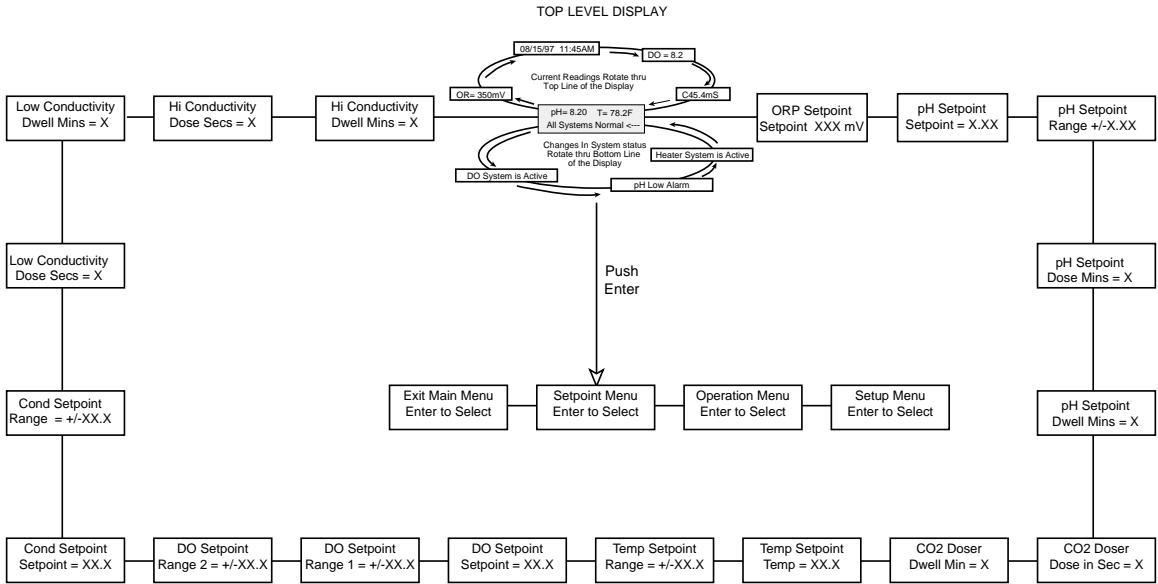

SETPOINTS MENU

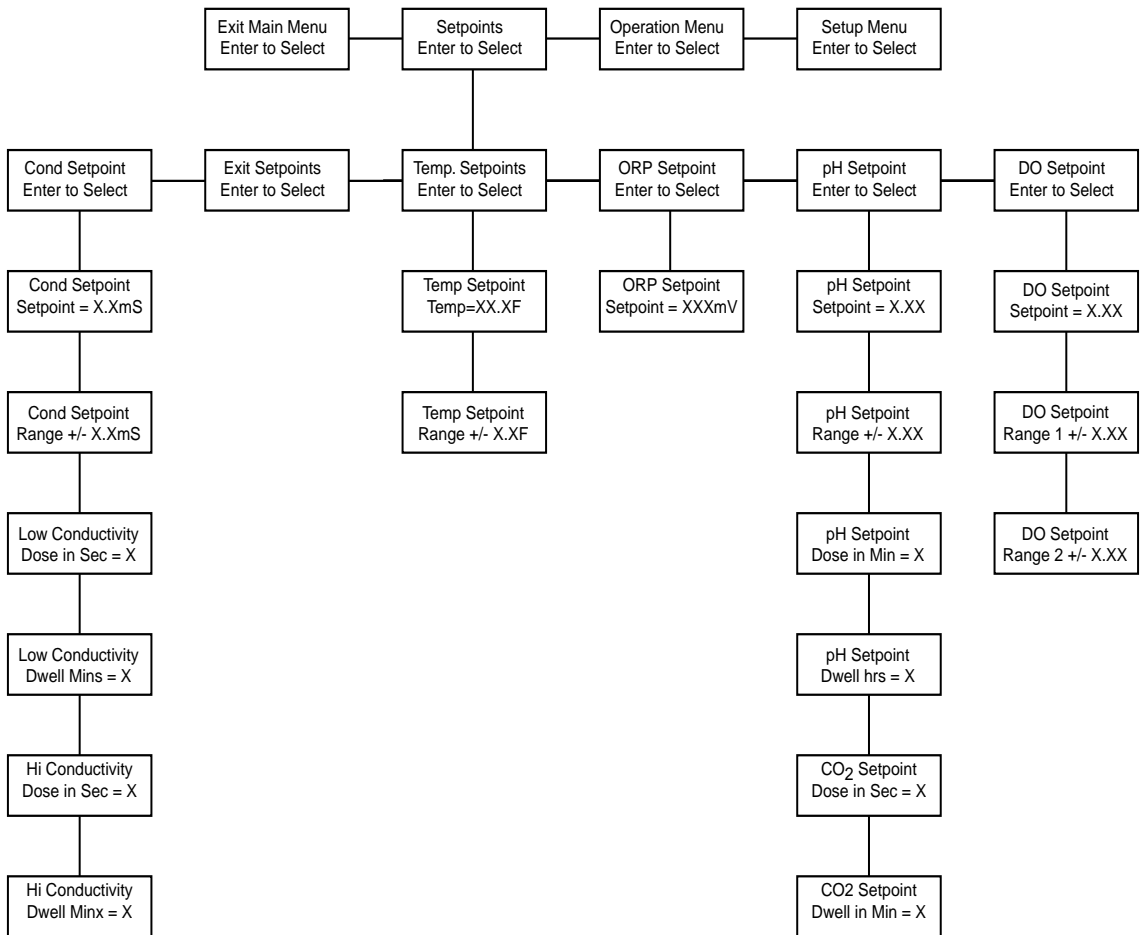

Menu Maps

OPERATION MENU

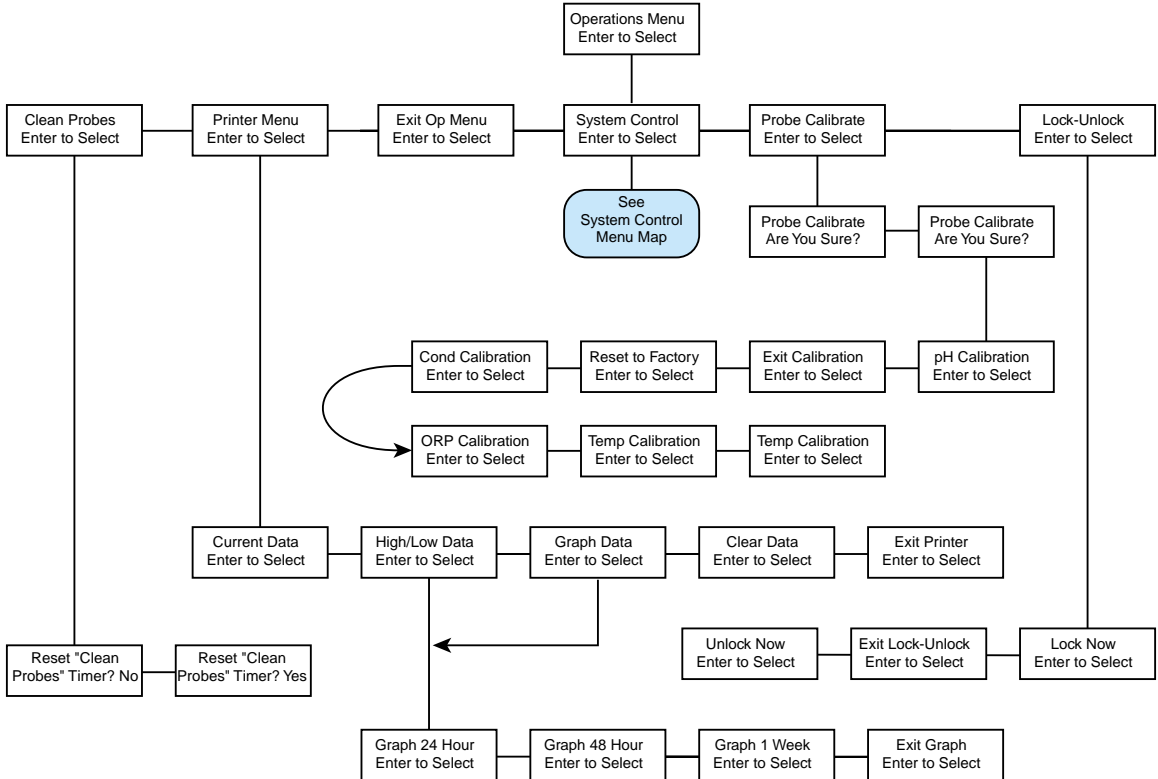

SETUP MENU

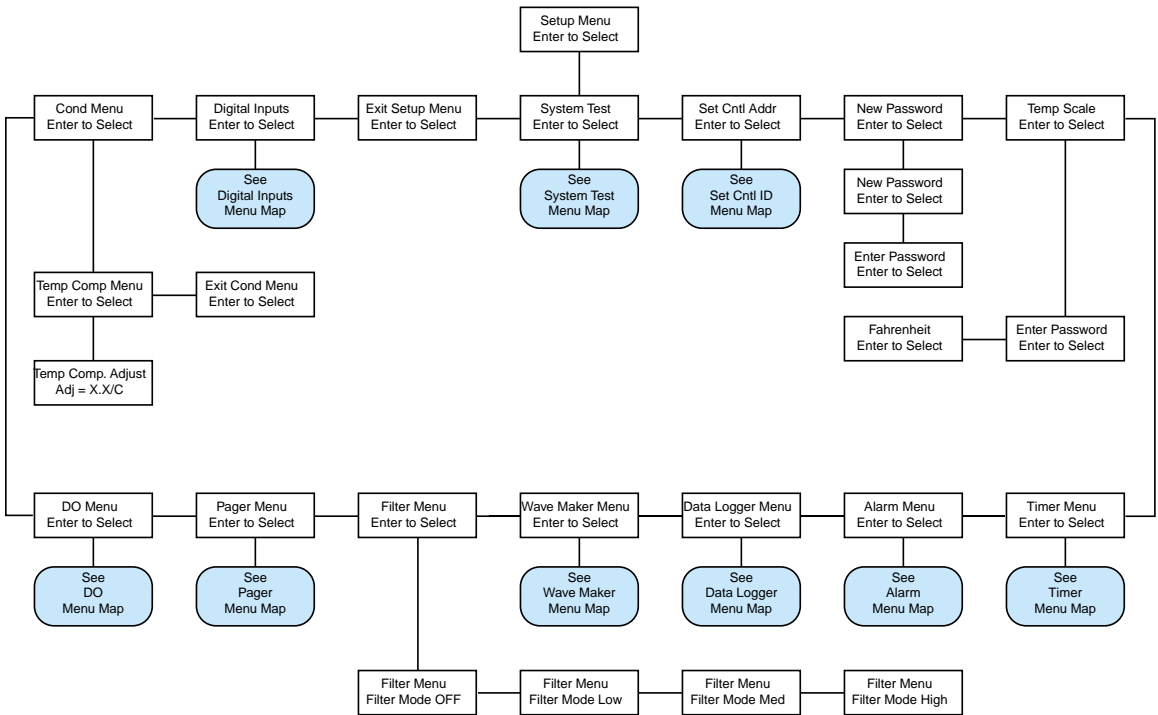

Menu Maps

SYSTEMS CONTROL MENU

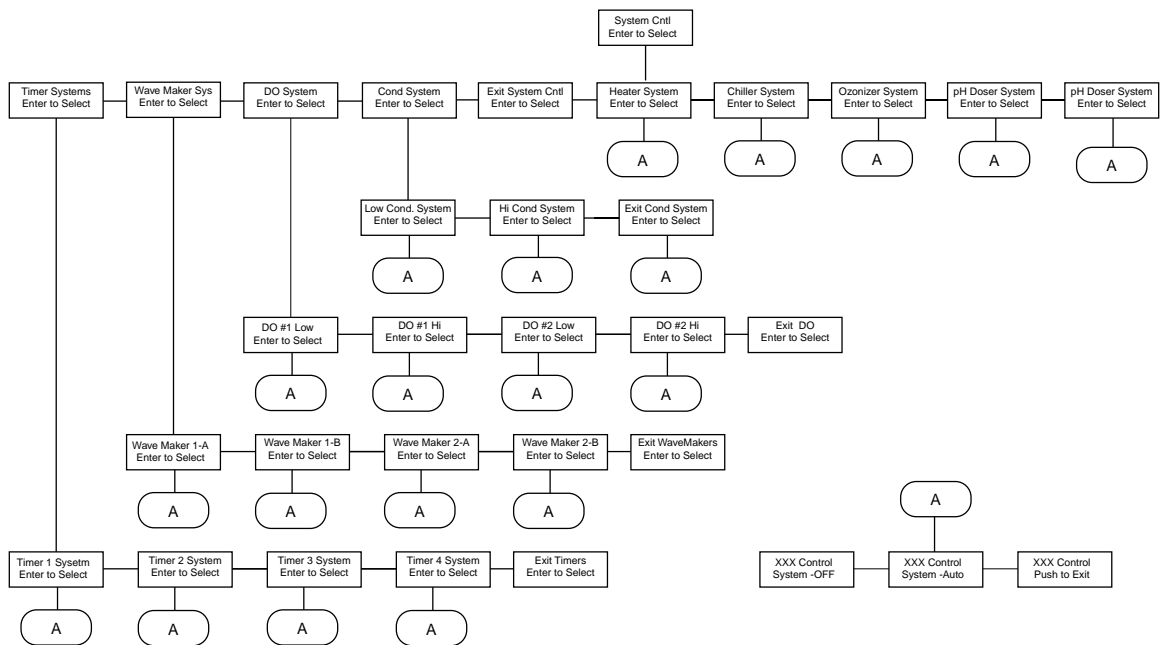

Menu Maps

SET (CONTROL) CNTL ID MENU

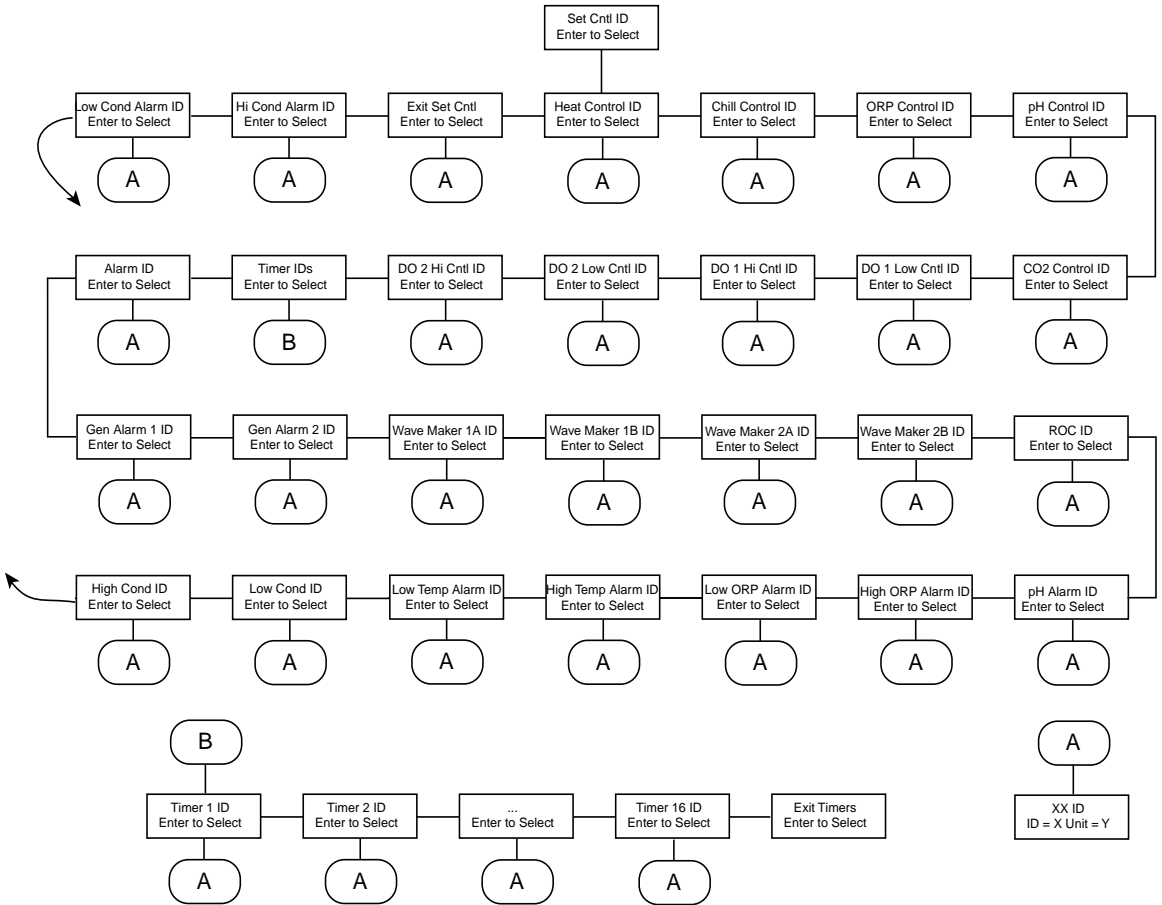

WAVE MAKER MENU

Wave Maker Menu

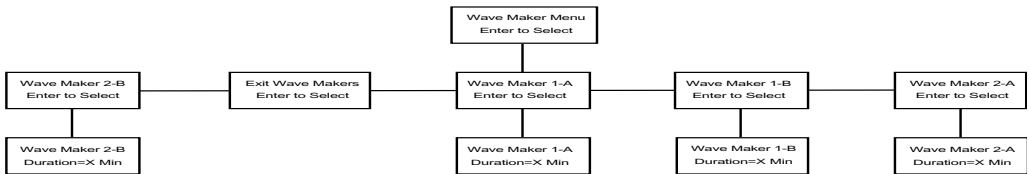

DO MENU

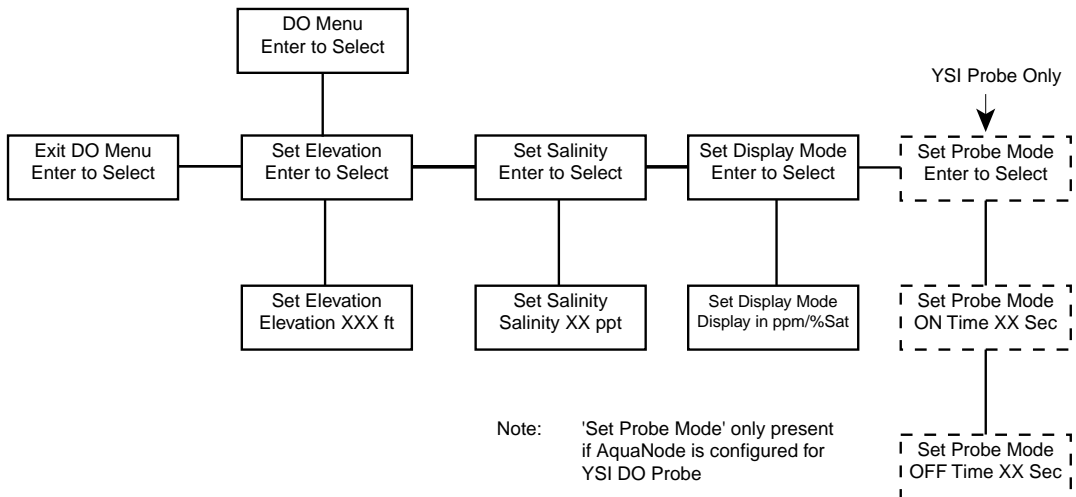

Menu Maps

TIMER MENU

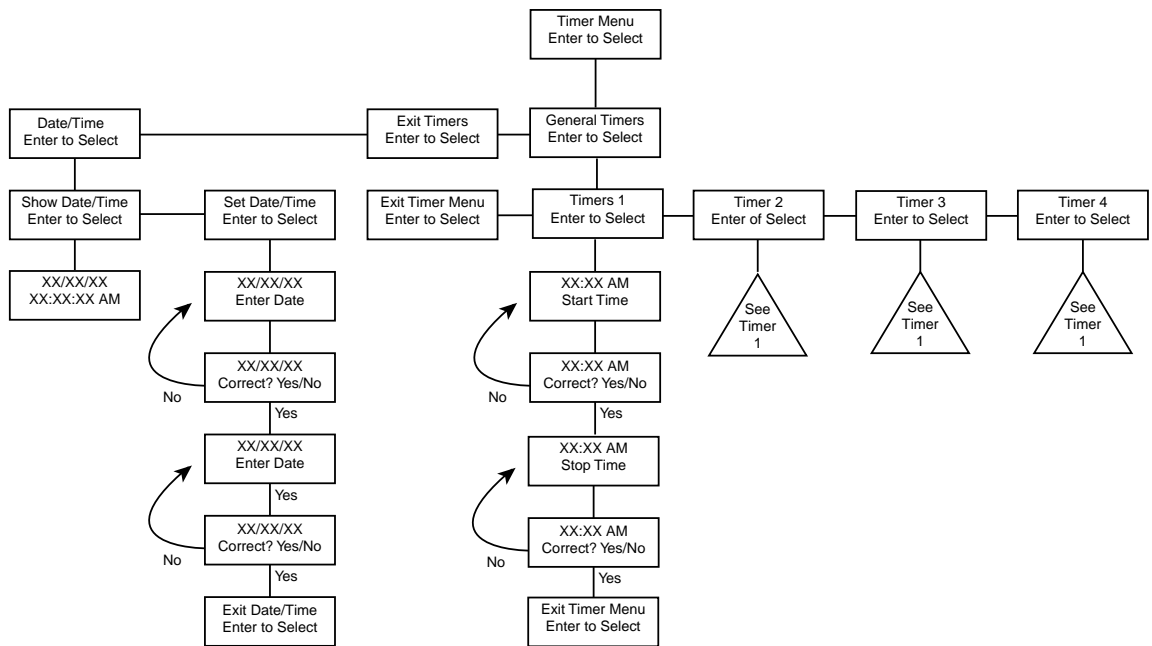

ALARM MENU

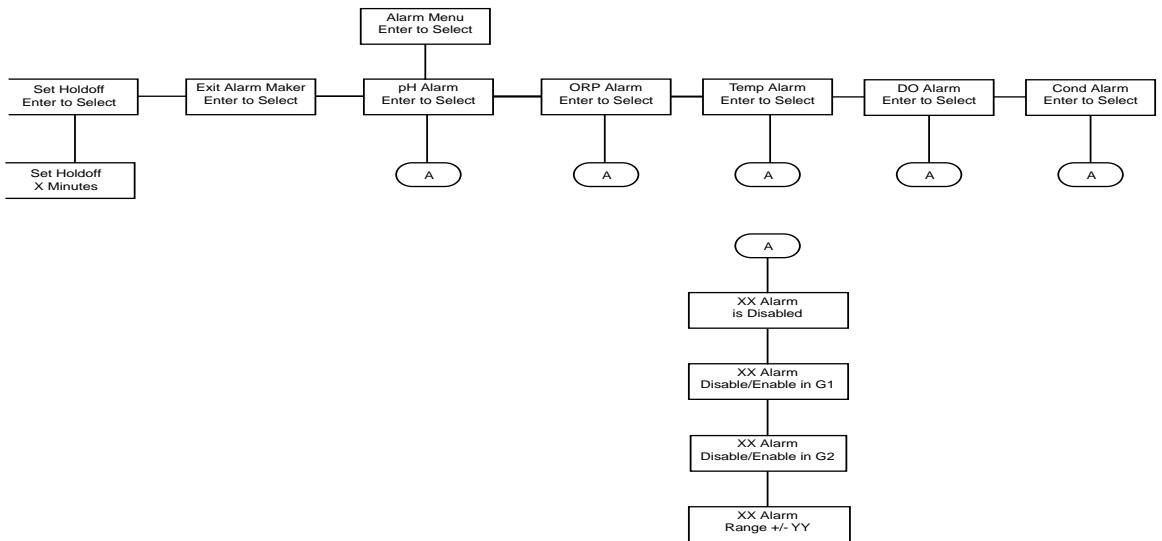

Menu Maps

DATA LOGGER MENU

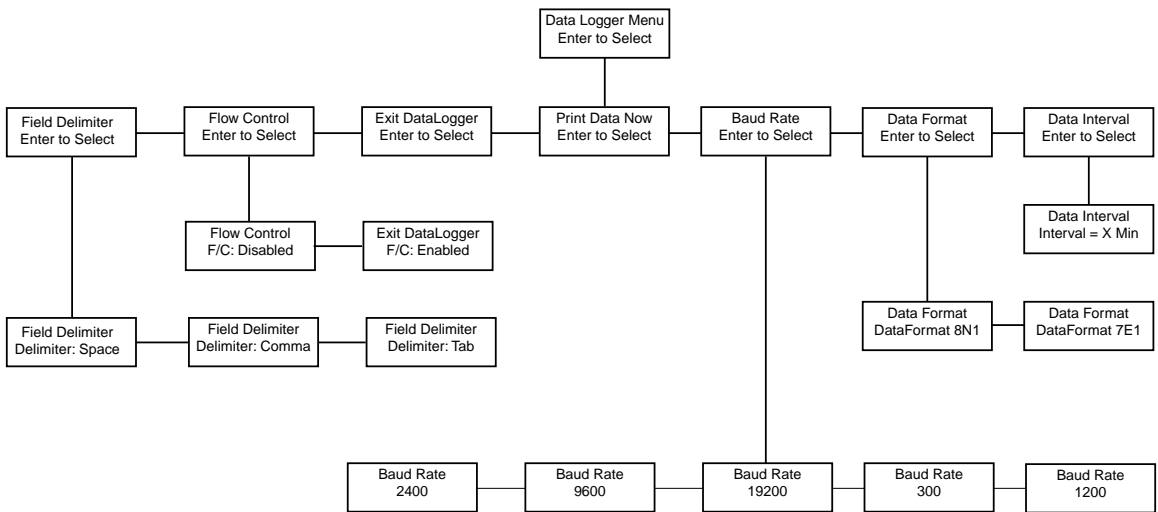

PAGER MENU

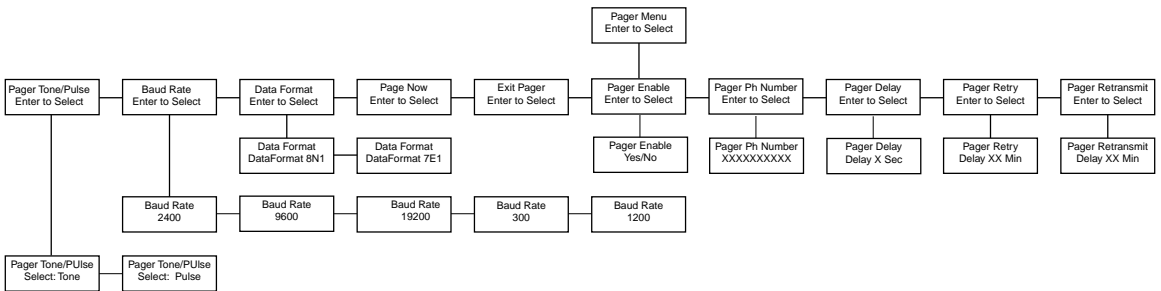

Menu Maps

DIGITAL INPUTS MENU

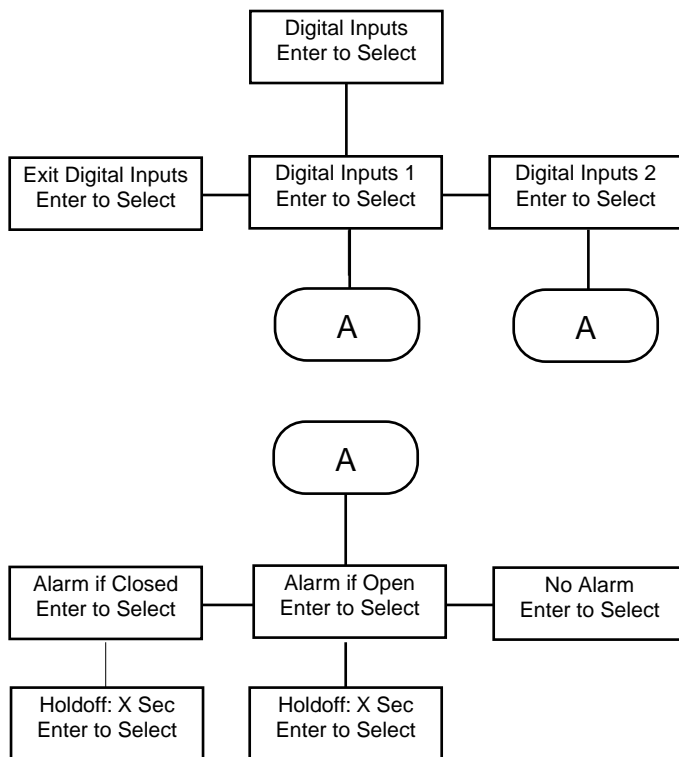

Appendix

B

Understanding The Water Quality Parameters

Water Quality

UNDERSTANDING THE WATER QUALITY PARAMETERS

Increasing your understanding of basic water chemistry will enhance your ability to interpret the data generated by your AquaNode controller. With the controller's assistance you can cultivate the ultimate aquatic environment. The following chapter covers five components vital to creating the optimal aquatic habitat: pH, ORP, temperature, conductivity, and dissolved oxygen.

TEMPERATURE

It is frequently desirable that the temperature of an aquatic environment remain stable over the course of a day. Varying a degree or two (Fahrenheit) is sometimes acceptable, but larger fluctuations can cause problems.

A heater or chiller is very helpful maintaining correct temperatures. It may be sufficient, however, simply to heat or air condition the room the aquatic environment is in. The body temperature of your aquatic pets and all other cold blooded animals is determined by their environment. As the temperature cools, their metabolic processes slow down. The ideal temperature is one at which your fish are active, eating and growing.

The ideal temperature range for salt water environments is 75° to 78° F. The ideal range for fresh water environments is 76° to 80° F. If you have questions about the requirements of a particular species, refer to the specialist at your local fish store.

Temperature should be altered gradually, with changes of no more than 2 °F or 1 °C in a 24-hour period. Your AQUANODE controller is ideal for maintaining water temperature since it makes constant incremental alterations.

pH

The pH of water refers to the degree to which an aquatic environment is acidic or alkaline. The pH scale ranges from 0 to 14.0, with a pH of 7.0 being neutral. Below 7.0 is acidic, and above 7.0 is basic. Natural sea water, for example, has a pH of about 8.3 which is slightly alkaline. The typical pH range for tropical marine fish is between 7.6 and 8.5

The pH probe must be calibrated with calibration solutions to assure the accuracy of the reading.

Because the pH changes on a logarithmic scale, not a linear one, the calibration solutions used should be on both sides of the average pH for the environment. For saltwater environments with an ideal pH of 8.3, the calibration solutions used should be 7 and 9 or 7 and 10. The pH of an aquatic environment fluctuates naturally from day to night. The pH tends to fall at night and rise, due to photosynthesis by plants, during the day. Therefore, a range of readings over the course of the day is normal, and a single test may not mean very much.

Wide fluctuations in pH can be fatal to fish and marine organisms. Therefore, small changes of no more than 0.1 unit of pH a day can be made by adding a buffer solution. With help from your AQUANODE controller, maintaining proper pH levels becomes easy. The controller monitors your pH levels and

instructs the doser control system to make necessary adjustments to replenish your pH depleted aqua system.

ORP

Oxidation Reduction Potential (ORP) is a measurement of the potential for chemical reactions which occur in the water. This potential is determined by measuring the millivolts (mV) present in the water.

ORP provides a useful indication of water purity. High ORP values indicate oxidation reactions greatly exceed reducing reactions. Low ORP values indicate reducing reactions greatly exceed oxidation reactions. ORP values in natural sea water (NSW) typically range from 350 to 400 mV. This corresponds to the ideal range for aquariums as well.

Artificial manipulation of ORP is accomplished with ozonization of the water.

CONDUCTIVITY

As its name implies conductivity measures the ability of a sample to conduct an electrical current. For liquids, conductivity is dependent on the amount of ionic compounds dissolved in the sample. Conductivity is useful for measuring total dissolved solids (TDS) and salinity. As a general rule, as ion concentration increases, conductivity rises. Although the conductivity measurement can not differentiate between the contributions from specific ions, it does give a general indication of the total ion concentration.

In saltwater, conductivity is generally used to determine the approximate salinity equivalent. Because all aquatic systems will experi-

ence a loss of water through evaporation, salinity will gradually rise over time. A decreasing salinity is often reflected by changes in the growth of algae (Esp. blue-green or other "slimy" algae, and a decline in the health of invertebrates.) In Appendix C on Page 5 shows the relationship between conductivity and salinity is shown.

For freshwater applications, conductivity is generally used to determine the general water quality.

In hydroponic applications conductivity is useful in measuring the concentration of nutrient solutions. Proper conductivity levels for various types of plants, in varying stages of growth are listed in the table below.

<u>Stage</u>	<u>Fruiting Plants</u>	<u>Leafy Plants</u>
Seedling	1600-1800µS	1400-1600µS
Average	2500µS	1800µS
Fruiting	2400-2600µS	N/A

DISSOLVED OXYGEN

Dissolved oxygen (D.O.) refers to the volume of oxygen that is contained in water. Oxygen enters the water by photosynthesis of aquatic biota and by the transfer of oxygen across the air-water interface (ecosystem productivity).

The amount of D.O. is a balance between two factors, ecosystem productivity and biological oxygen demand (B.O.D., i.e. fishes, microorganisms). The productivity, which is measured in grams of carbon produced, is deter-

Water Quality

mined by the amount of photosynthetic plants and must be great enough to support the number of organisms undergoing respiration, or B.O.D. In short, the amount of oxygen being produced, as a by-product of photosynthesis must exceed the amount needed to support the organisms undergoing respiration. The amount of dissolved oxygen in an ecosystem is measured in mg/l and ranges from 0 to 18 (a reading higher than 18 is impossible).

The amount of oxygen that can be held by the water also depends on the water temperature, salinity, and pressure. Gas solubility increases with decreasing temperature (colder water holds more oxygen). Gas solubility increases with decreasing salinity (freshwater holds more oxygen than does saltwater). Both the partial pressure and the degree of saturation of oxygen will change with altitude. Finally, gas solubility decreases as pressure decreases. Thus, the amount of oxygen absorbed in water decreases as altitude increases because of the decrease in relative pressure.

Oxygen losses quickly occur when water temperatures rise, when plants and animals respire, and when microbes aerobically decompose organic matter. Although substantial fluctuations in D.O. levels appear (such as at night when O₂ is no longer being

produced), drastic changes, often lead to massive deaths of aquatic organisms and need to be carefully monitored.

(Microbes play a key role in the loss of oxygen from surface waters. Microbes use oxygen as energy to break down long-chained organic molecules into simpler, more stable end-products such as carbon dioxide, water, phosphate and nitrate. As microbes break down the organic molecules, oxygen is removed from the system and must be replaced by exchange at the air-water interface.)

Appendix

C

Conversion Tables

Oxygen Solubility Table

Solubility of Oxygen in mg/l in Water Exposed to Water-Saturated Air at 760 mm Hg Pressure

Salinity = Measure of quantity of dissolved salts in water

Chlorinity = Measure of chloride content, by mass, of water.

$$S(\text{‰}) = 1.80655 \times \text{Chlorinity} (\text{‰})$$

Temp °C	Chlorinity:0 Salinity:0	5.0 ppt 9.0 ppt	10.1 ppt 18.1 ppt	15.0 ppt 27.1 ppt	20.0 ppt 36.1 ppt	25.0 ppt 45.2 ppt
0.0	14.62	13.73	12.89	12.10	11.36	10.66
1.0	14.22	13.36	12.55	11.78	11.07	10.39
2.0	13.83	13.00	12.22	11.48	10.79	10.14
3.0	13.46	12.66	11.91	11.20	10.53	9.90
4.0	13.11	12.34	11.61	10.92	10.27	9.66
5.0	12.77	12.02	11.32	10.66	10.03	9.44
6.0	12.45	11.73	11.05	10.40	9.80	9.23
7.0	12.14	11.44	10.78	10.16	9.58	9.02
8.0	11.84	11.17	10.53	9.93	9.36	8.83
9.0	11.56	10.91	10.29	9.71	9.16	8.64
10.0	11.29	10.66	10.06	9.49	8.96	8.45
11.0	11.03	10.42	9.84	9.29	8.77	8.28
12.0	10.78	10.18	9.62	9.09	8.59	8.11
13.0	10.54	9.96	9.42	8.90	8.41	7.95
14.0	10.31	9.75	9.22	8.72	8.24	7.79
15.0	10.08	9.54	9.03	8.54	8.08	7.64
16.0	9.87	9.34	8.84	8.37	7.92	7.50
17.0	9.67	9.15	8.67	8.21	7.77	7.36
18.0	9.47	8.97	8.50	8.05	7.62	7.22
19.0	9.28	8.79	8.33	7.90	7.48	7.09
20.0	9.09	8.62	8.17	7.75	7.35	6.96
21.0	8.92	8.46	8.02	7.61	7.21	6.84

Conversion Tables

Temp °C	Chlorinity:0 Salinity:0	5.0 ppt 9.0 ppt	10.1 ppt 18.1 ppt	15.0 ppt 27.1 ppt	20.0 ppt 36.1 ppt	25.0 ppt 45.2 ppt
22.0	8.74	8.30	7.87	7.47	7.09	6.72
23.0	8.58	8.14	7.73	7.34	6.96	6.61
24.0	8.42	7.99	7.59	7.21	6.84	6.50
25.0	8.26	7.85	7.46	7.08	6.72	6.39
26.0	8.11	7.71	7.33	6.96	6.62	6.28
27.0	7.97	7.58	7.20	6.85	6.51	6.18
28.0	7.83	7.44	7.08	6.73	6.40	6.09
29.0	7.69	7.32	6.96	6.62	6.30	5.99
30.0	7.56	7.19	6.85	6.51	6.20	5.90
31.0	7.43	7.07	6.73	6.41	6.10	5.81
32.0	7.31	6.96	6.62	6.31	6.01	5.72
33.0	7.18	6.84	6.52	6.21	5.91	5.63
34.0	7.07	6.73	6.42	6.11	5.82	5.55
35.0	6.95	6.62	6.31	6.02	5.73	5.46
36.0	6.84	6.52	6.22	5.93	5.65	5.38
37.0	6.73	6.42	6.12	5.84	5.56	5.31
38.0	6.62	6.32	6.03	5.75	5.48	5.23
39.0	6.52	6.22	5.98	5.66	5.40	5.15
40.0	6.41	6.12	5.84	5.58	5.32	5.08
41.0	6.31	6.03	5.75	5.49	5.24	5.01
42.0	6.21	5.93	5.67	5.41	5.17	4.93
43.0	6.12	5.84	5.58	5.33	5.09	4.86
44.0	6.02	5.75	5.50	5.25	5.02	4.79
45.0	5.93	5.67	5.41	5.17	4.94	4.72

Note: This table is provided for your information only. It is **NOT** required when calibrating the AquaNode in accordance with the instructions outlined in the chapter entitled Operation and maintenance.

DO Calibration Values Table

Calibration values for various atmospheric pressures and altitudes.

Note: This table is for information only. It is not required for calibration.

Pressure Inches of Hg	Pressure mm of Hg	Pressure kPA	Altitude in Feet	Altitude in meters	Calibration Value in %
30.23	768	102.3	-276	-84	101
29.92	760	101.3	0	0	100
29.61	752	100.3	278	85	99
29.33	745	99.3	558	170	98
29.02	737	98.3	841	256	97
28.74	730	97.3	1126	343	96
28.43	722	96.3	1413	431	95
28.11	714	95.3	1703	519	94
27.83	707	94.3	1995	608	93
27.52	699	93.3	2290	698	92
27.24	692	92.2	2587	789	91
26.93	684	91.2	2887	880	90
26.61	676	90.2	3190	972	89
26.34	669	89.2	3496	1066	88
26.02	661	88.2	3804	1160	87
25.75	654	87.1	4115	1254	86
25.43	646	86.1	4430	1350	85
25.12	638	85.1	4747	1447	84
24.84	631	84.1	5067	1544	83
24.53	623	83.1	5391	1643	82
24.25	616	82.1	5717	1743	81
23.94	608	81.1	6047	1843	80
23.62	600	80.0	6381	1945	79
23.35	593	79.0	6717	2047	78
23.03	585	78.0	7058	2151	77
22.76	578	77.0	7401	2256	76
22.44	570	76.0	7749	2362	75
22.13	562	75.0	8100	2469	74
21.85	555	74.0	8455	2577	73
21.54	547	73.0	8815	2687	72
21.26	540	71.9	9178	2797	71
20.94	532	70.9	9545	2909	70
20.63	524	69.9	9917	3023	69
20.35	517	68.9	10293	3137	68

Conductivity vs. Salt Concentration

Conductivity will vary with temperature. Conductivity values shown at 25 and 30 degrees C
Note: This table is for information only. It is not required for calibration.

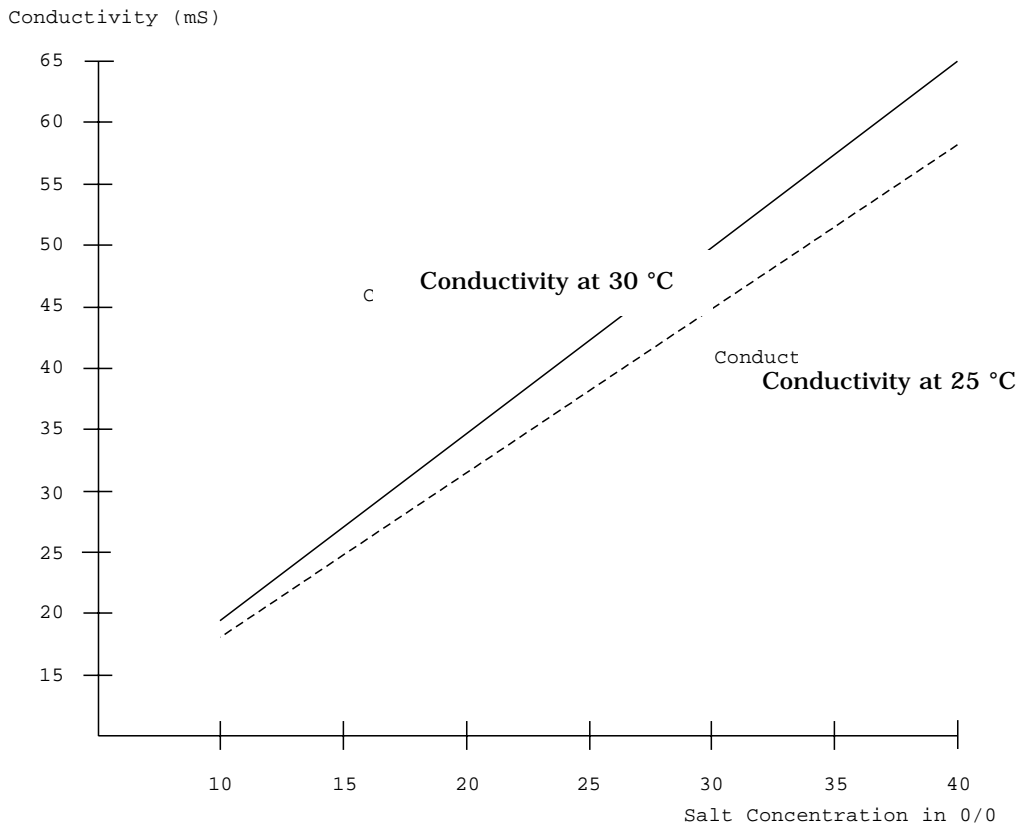

Conductivity, Salinity, and Density Comparison

Conductivity at 25 C (mS/cm)	Salinity at at 25 C (‰)	Density at 25 C (‰) (g/cm ³)
40.0	25.2	1.0187
41.0	26.2	1.0193
42.0	26.9	1.0198
43.0	27.7	1.0204
44.0	28.4	1.0209
45.0	29.1	1.0214
46.0	29.8	1.0220
47.0	30.5	1.0225
48.0	31.3	1.0232
49.0	32.0	1.0238
50.0	32.7	1.0244
51.0	33.4	1.0250
52.0	34.1	1.0256
53.0	34.8	1.0262
54.0	35.5	1.0268
55.0	36.1	1.0274

Appendix

D

Upgrading
H₂O/S
Flash
System
in
AquaNode

Upgrading H₂O/S Flash

H₂O/S FLASH DOWNLOADER

The AquaNode is designed to be able to have its built-in software (H₂O/S System) upgraded without the need to have the product returned to Aquadyne.



The system is built using the latest Flash memory technology. The Flash memory can be reprogrammed using a special program available from Aquadyne called the 'ADLoader'. This software is available through the internet at the following addresses:

<ftp://www.aquadyne.com>

Once ADLoader is installed on your local computer upgrading is a simple matter of connecting the AquaNode to the computer and running the ADLoader application. The entire process is automatic and requires no user intervention. ADLoader will also go out to the internet and check to see if there is a newer release of the H₂O/S software available for the AquaNode and automatically download it from our ftp site for you.

Downloading the H₂O/S Software from the Internet

1. Start Microsoft Internet Explorer, Netscape Navigator, or another Internet browser.
2. In the browser's URL text box, type `ftp://www.aquadyne.com`
3. On Aquadyne's FTP page, click Downloader.EXE.
4. When asked whether you want to open Downloader.EXE or save it to disk, choose Save it to disk.
5. In the Windows 95 Save As dialog box, select `C:\Windows\Temp`, leave the file name as Downloader in the Name text box, and then click Save.
6. When the download is complete simply run the application 'Downloader.exe'. It will self extract all the necessary files and automatically run the installation program. Follow the instructions provided within the installation application to complete the installation process.

Installing the H₂O/S Software from CD-ROM or Floppy

1. In the Install Program from Floppy Disk or CD-ROM dialog box and click Next.
2. From the Start menu locate the run option and select it.
3. When the run dialog box comes up select the Browse button.

4. In the Browse dialog box, select the drive where the where the installation software is located. Typically drive A: if it is a floppy or the CD rom drive designation.
5. Once you selected the drive locate the file called 'Setup.exe' on the disk or if it is a CD rom drive in the folder named 'Downloader'



If you plan to download the unit via phone. Aquadyne strongly recommends that the download process be monitored by having a support person at the AquaNode unit should problems arise in the download process.

6. Run the program named 'Setup.exe'. Follow the instructions provided within the installation application to complete the installation process.

Running the H₂O/S Software

The H₂O/S downloader is capable of upgrading the AquaNode by either connecting the AquaNode directly to one of the computers serial communications ports or by connecting to the AquaNode via modem. Refer to the Section 1 in this manual regarding both modem connections to the AquaNode and Direct connection via a serial port on the computer.

The H₂O/S downloader software is very easy to use and will prompt you through the upgrade process for the AquaNode. A new menu item in your start menu is called ADLoader. Select that to start the downloader software.

During the download sequence the AquaNode is no longer running the H₂O/S software. It will run a special loader which is built into the AquaNode. Once the download process is begun it **MUST** be allowed to complete successfully. If the process is terminated for any reason the Aqua-Node will automatically run the built-in downloader on startup in an attempt to complete the download process.

If the download process is only partially complete the AquaNode will NOT be able to perform any Monitoring or Control operations!



During the Download process all system functions such as monitoring, control and alarming are terminated. Make sure that the systems that the AquaNode is managing are disabled during the download process.

Upgrading H2O/S Flash

Once the download completes successfully. The AquaNode will perform a check of the system memory built into the AquaNode and automatically reset the controller. During the Initialization process you should see the version number of the new software just installed in the controller displayed in the LCD screen on startup.



CAUTION

In the very rare event that the AquaNode is unable to startup either in the downloader or the H2O/S system. You can force the software into the downloader by holding down the Enter and Right Buttons keys at the same time while power is first applied to the system. No indication of any kind will be present in the LCD screen but the controller will respond to the downloader software in the PC.

Appendix

E

Product Warranty

Product Warranty

Aquadyne Computer Corporation warrants articles of equipment manufactured by it to be free from defects in material and workmanship under normal use and service. Aquadyne's obligation under this warranty is limited to making good at its factory any defective controller or satellite which is returned intact to Aquadyne or to one of Aquadyne's authorized service centers within one year of delivery of the product to the original purchaser. The shipping must be prepaid until the product has been determined to be defective.

Probes supplied by Aquadyne carry a 90-day warranty from date of purchase with the same conditions as the controller and satellite warranty.

Aquadyne warrants any repair or replacement of its products for thirty (30) days or for the remainder of the original warranty, whichever period is longer.

This warranty shall not apply to any article of equipment which has been repaired or altered outside the Aquadyne Computer Corporation factory or authorized service centers, nor which has been subject to misuse, negligence or accident, incorrect wiring by others, or installation or use not in accord with instructions furnished by the manufacturer.

Aquadyne's warranty obligation has limited transportation expenses. Products believed by buyer to be defective shall be returned to Aquadyne, transportation and insurance prepaid by buyer. If Aquadyne determines the product is defective in operation, workmanship or material, the product will be repaired or replaced and returned to the

buyer with transportation and insurance prepaid. If Aquadyne determines that the product is operating normally and the buyer was misusing the product, Aquadyne may charge the buyer for labor and shipping charges.

Aquadyne will give the buyer every possible consideration and will notify the buyer of products not subject to warranty allowance; and promptly upon receiving such notice, the buyer will notify Aquadyne as to whether the product should be repaired, returned to the buyer without repair or otherwise disposed of. Products left in Aquadyne's possession longer than thirty (30) days without the buyer's notice of disposition will be subject to a stocking and handling charge. For replaced items, the buyer will pay the established Aquadyne price. For repair labor, the buyer will pay Aquadyne's established maintenance service rate. Under all circumstances, a product not subject to warranty coverage will free Aquadyne of all transportation charges.

EXCEPT FOR THE EXPRESS WARRANTY SET FORTH HEREIN, AQUADYNE COMPUTER CORPORATION GRANTS NO WARRANTIES, EITHER EXPRESS OR IMPLIED, OF MERCHANTABILITY AND FITNESS. THE STATED EXPRESS WARRANTY IS IN LIEU OF ALL LIABILITIES OR OBLIGATIONS OF AQUADYNE COMPUTER CORPORATION FOR DAMAGES INCLUDING, BUT NOT LIMITED TO, CONSEQUENTIAL DAMAGES OCCURRING OUT OF OR IN CONNECTION WITH THE DELIVERY, USE OR PERFORMANCE OF AQUADYNE COMPUTER CORPORATION PRODUCTS.

Buyer's remedies for breach of warranty shall be limited to repair, or replacement subject to adjustment as stated herein, and full or partial adjustment to purchase price.